

# CITROËN

---

CATALOGUE GÉNÉRAL

des

PIÈCES DÉTACHÉES

---

CARROSSERIES

---

TOURISME,

UTILITAIRES ET POIDS LOURDS

Modèles 1934-1935

---



N° 350

EN VIGUEUR A DATER DU 1<sup>ER</sup> MARS 1936

# CITROËN

---

CATALOGUE GÉNÉRAL  
des  
PIÈCES DÉTACHÉES  
CARROSSERIES  
TOURISME,  
UTILITAIRES ET POIDS LOURDS  
Modèles 1934-1935

---

ILLUSTRATIONS



N° 350

SOCIÉTÉ ANONYME ANDRÉ CITROËN

Capital : 210.000.000 de Francs

---

SERVICE DES PIÈCES DÉTACHÉES

147, Rue du Président-Wilson, à LEVALLOIS-PERRET (Seine)

Adresse Téléphonique : CARNOT 62-11 à 62-14

INTER-CARNOT 80

R. C. Seine : 216.018 B

*En vigueur à dater du 1<sup>er</sup> Mars 1936*



## TABLE DES MATIÈRES

		NUMÉROS DES PAGES	
		PLANCHES	TEXTE
<b>AUVENT</b>	Cache-encoche de direction.....		25
	Dôme d'auvent.....	13 à 15	21
	Pare-soleil.....	13 et 15	22 et 23
	Plancher incliné.....	15	24 et 25
	Planche porte-appareils.....	13 et 15	26 et 27
	Rétroviseur.....	13 et 15	23
	Tablier.....	15	24
	Tête d'auvent.....	13 à 15	21 et 22
	Volet d'aération.....	14 et 15	25 et 26
<b>ÉLÉMENTS DE CARROSSERIE</b>	Arceaux de bâche.....		62
	Bâche.....		62
	Bas de marche.....	25	51
	Caisses nues et complètes.....		48 à 50
	Capote de roadster 7 et 11.....	29	61
	Coffre à bagages.....	26	53
	Coffre de spider.....	26	54 et 55
	Fixation de caisse.....		63
	Hayon.....		57
	Jet d'eau.....	25	51
	Panneau AR commerciale.....	27	56
	Pavillon.....		52
	Planchers.....	28	59 et 60
	Porte AR de fourgon.....		58
<b>GLACES</b> .....	18 et 19	34 à 36	
<b>HABILLAGE</b>	Ailes AV.....	1 à 4	1 et 2
	Ailes AR.....	6 et 7	10
	Attache-capot.....	1 à 4	7
	Bavette AV T23.....	3	3
	Bavette pare-boue sur aile AV 7 et 11.....	1 et 2	5
	Bavolet de marchepied.....	12	20
	Butée de capot.....	1 à 4	7
	Coffre de batterie et à outils sur ailes AV.....	3 et 4	8
	Housse de roue de secours 7 et 11.....	6	12 et 13
	Jonc d'aile.....		5
	Joue d'aile AV 7 et 11.....	1 et 2	3
	Malle AR.....	8 et 9	14 et 15
	Marchepied.....	12	20
	Pare-chocs AV et AR.....	10 et 11	17 et 19
	Plaque de police AV.....	10 et 11	19
	Plate-forme AR et porte-bagages pliant.....	8 et 9	15 et 16
Porte-roue de secours 7 et 11.....	6	11 et 12	



## TABLE DES MATIÈRES

	NUMÉROS DES PAGES		
	PLANCHES	TEXTE	
<b>HABILLAGE</b> <i>(suite)</i>	Porte-roue sur aile AV (MI) .....	5	9
	Porte-roue de secours sur malle (MI) .....	8	14 et 15
	Supports d'ailes AV .....	1 à 4	3 à 5
	Supports de pare-chocs AV .....	10 et 11	17
	Supports de pare-chocs AR .....	10 et 11	19
	Support d'avertisseur .....	10 et 11	18
	Support de phare et fixation .....	1 à 4	5 et 6
	Tôle d'habillage AV (MI) .....	3	3
	Tôle d'habillage AR 7 et 11 .....	6	11
<b>PARE-BRISE</b> .....	16 et 17	28 à 33	
<b>PORTIÈRES</b>	Bas de glace .....		41 à 43
	Butée .....	20 à 22	40 et 41
	Cale-porte .....	20 à 22	40 et 41
	Charnière .....	20 à 22	38 et 39
	Coulisse de glace .....	20 à 22	41 à 44
	Encadrement de glace de porte .....	20 à 22	41 à 44
	Gâche de porte .....	23 et 24	45 et 46
	Joint d'étanchéité de glace de porte .....	20 à 22	41 à 44
	Joint d'étanchéité de porte .....	20 à 22	37 et 38
	Lève-glaces .....	20 à 22	39 et 40
	Motifs de porte .....	23	47
	Poignées .....	23 et 24	45 et 46
	Porte complète .....	20 à 22	37
	Rampe de porte .....	20 à 22	44
	Serrure .....	23 et 24	45 et 46
	Tirant de porte .....	20 à 22	41
<b>SELLERIE ET ACCESSOIRES</b>	Brassières .....		65
	Coussin .....	30 à 32	66 à 70
	Dossier .....	30 à 32	66 à 70
	Filets chapelière .....		65
	Fixation des garnitures .....		75
	Garniture intérieure .....		72 et 73
	Matières diverses de sellerie .....		75 et 76
	Sièges .....	30 à 32	66 à 70
	Stores .....		64
	Strapontins .....	30 à 32	70 et 71
Tapis .....		74	



## LÉGENDES DES SYMBOLES SERVANT A LA DÉSIGNATION DES CARROSSERIES

SYMBOLES		DÉSIGNATION DES CARROSSERIES
CARROSSERIES	CHASSIS	
<b>“ 7 ” ET “ 11 ”</b>		
BPV	7	BERLINE Normale, 4 places, 4 portes.
BPVS	11 légère	BERLINE Normale, 4 places, 4 portes.
BPVL	11	BERLINE Normale, 6 places, 4 portes.
CPV	7	FAUX cabriolet, 2 places, 2 portes, avec coffre AR.
CPVS	11 légère	FAUX cabriolet, 2 places, 2 portes, avec coffre AR.
CPVL	11	FAUX cabriolet, 3 places, 2 portes, avec coffre AR.
RPV	7	CABRIOLET, 2 places, avec spider.
RPVS	11 légère	CABRIOLET, 2 places, avec spider.
RPVL	11	CABRIOLET, 3 places, avec spider.
SPVF5	11	CONDUITE intérieure, 5 places, 4 portes, 6 glaces.
SPVF6	11	CONDUITE intérieure, 6 places, 4 portes, 6 glaces.
FPVF7	11	FAMILIALE, 7 places, 4 portes, 2 strapontins face à la route.
FPVF9	11	FAMILIALE, 9 places, 4 portes, 3 strapontins face à la route.
LPVL	11	COUPÉ limousine, 2 places AV, 3 places AR, 4 portes.
LPVF	11	COUPÉ limousine, 2 places AV, 2 strapontins, 3 places AR.
TPVF	11	TAXI, 7 places, 4 portes.
<b>MI TOURISME</b>		
BL	MI 1 <sup>m</sup> ,34	BERLINE, 4 places,
BC	MI 1 <sup>m</sup> ,34	BERLINE commerciale.
BN	MI 1 <sup>m</sup> ,44	BERLINE, 5 places.
BNC	MI 1 <sup>m</sup> ,44	BERLINE commerciale.
CN	MI 1 <sup>m</sup> ,44	CONDUITE intérieure, 5 places.
FNC	MI 1 <sup>m</sup> ,44	CONDUITE intérieure commerciale.
FN	MI 1 <sup>m</sup> ,44	FAMILIALE, 7 places.



SYMBOLES		DÉSIGNATION DES CARROSSERIES
CARROSSERIES	CHASSIS	
<b>MI UTILITAIRES ET POIDS LOURDS</b>		
AF5	500 K	CABINE fermée, 2 places.
BO	500 K	BOULANGÈRE.
FO	500 K	FOURGON.
AF8	850 K	CABINE fermée, 2 places.
FOHP	850 K	FOURGON profilé surélevé.
FOHR	850 K	FOURGON profilé réduit.
BOHR	850 K	BOULANGÈRE réduite.
AF12	1.200 K	CABINE fermée, 3 places.
FOD	1.200 K	FOURGON.
CBD	1.200 K	CAMIONNETTE bâchée.
PLD	1.200 K	PLATE-FORME à ridelles rabattables.
PLDT	1.200 K	PLATE-FORME à ridelles, bâchée.
AF15	T 23	CABINE fermée, 3 places.
AFO15	T 23	CABINE fermée, 3 places avec communication intérieure.
FOPQ	T 23	FOURGON profilé.
PLQ	T 23	PLATEAU à ridelles rabattables.
PLTQ	T 23	PLATEAU à ridelles, bâchée.
CBQ	T 23	CAMION bâché.
AF25	T 32	CABINE fermée, 3 places.
AFO25	T 32	CABINE fermée, 3 places avec communication intérieure.
FOAP	T 32	FOURGON profilé sur châssis long.
FOCP	T 32	FOURGON profilé sur châssis court.
PLAR	T 32	PLATEAU à ridelles rabattables, sur châssis long.
PLCR	T 32	PLATEAU à ridelles rabattables, sur châssis court.
PLTAR	T 32	PLATEAU à ridelles, bâchée, sur châssis long.
PLTCR	T 32	PLATEAU à ridelles, bâchée, sur châssis court.
PLV	T 45	PLATEAU à ridelles rabattables, sur châssis long.
PCV	T 45	PLATEAU à ridelles rabattables, sur châssis court.
PLVT	T 45	PLATEAU à ridelles, bâché, sur châssis long.
PCVT	T 45	PLATEAU à ridelles, bâché, sur châssis court.

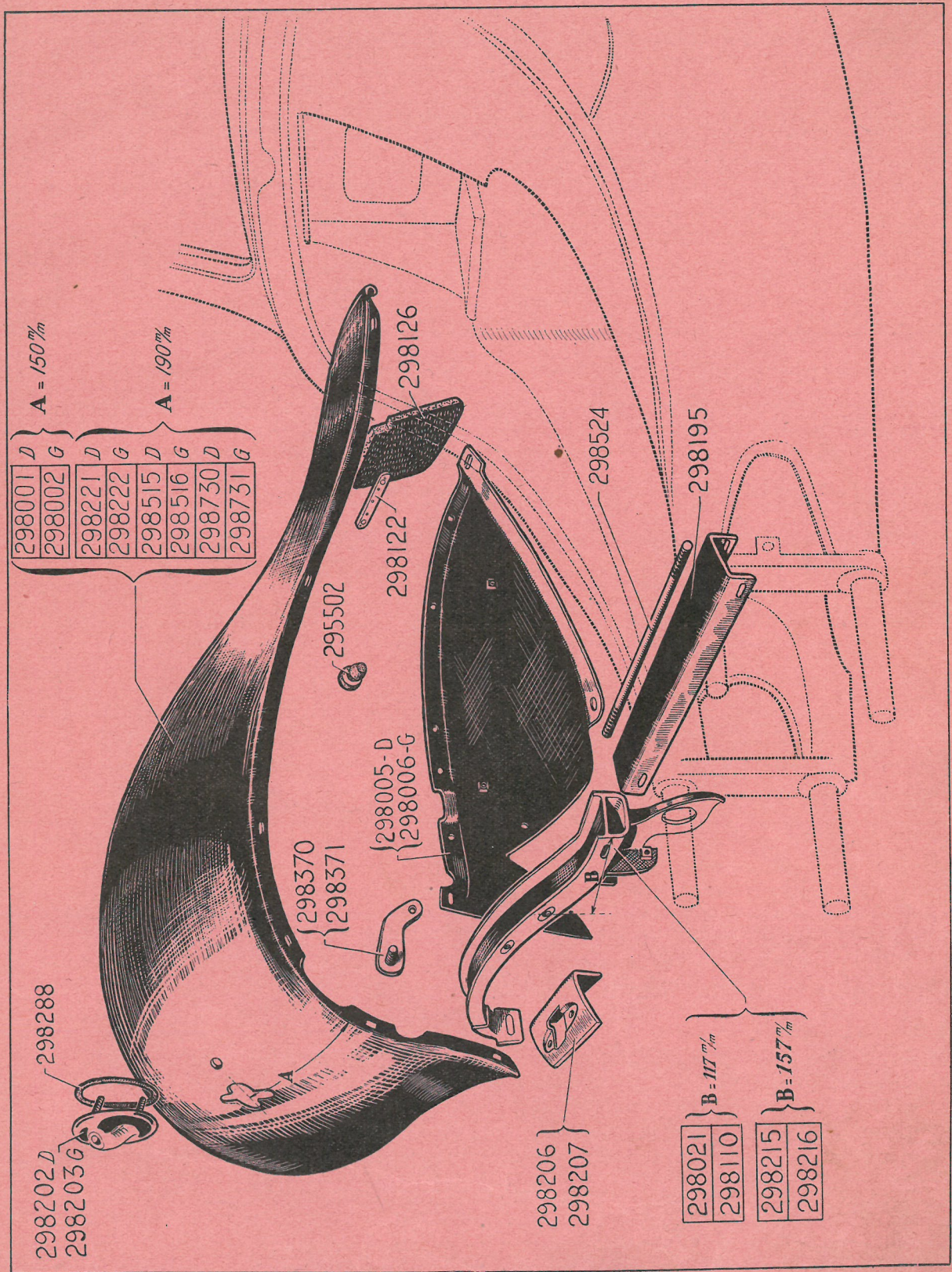

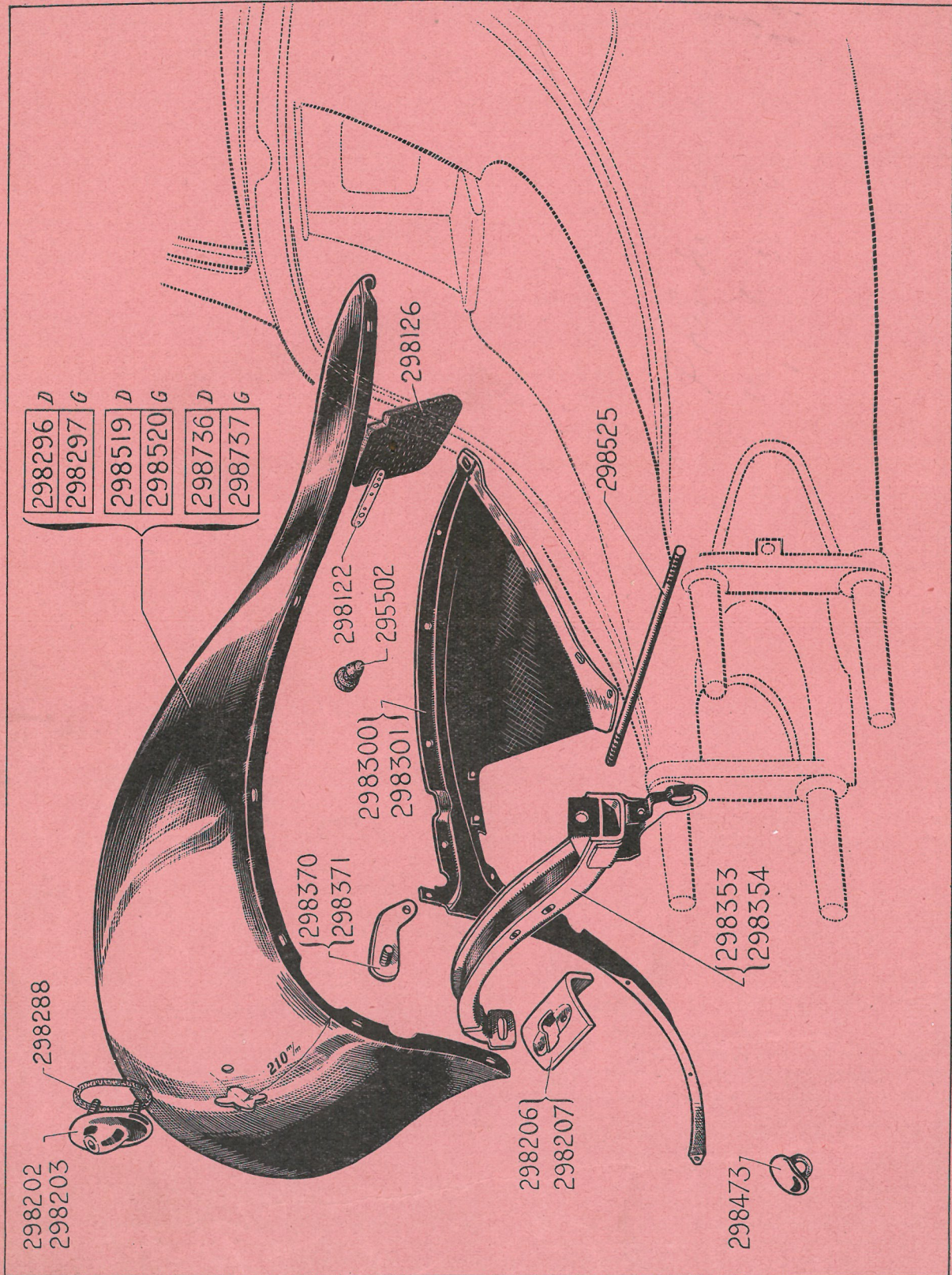



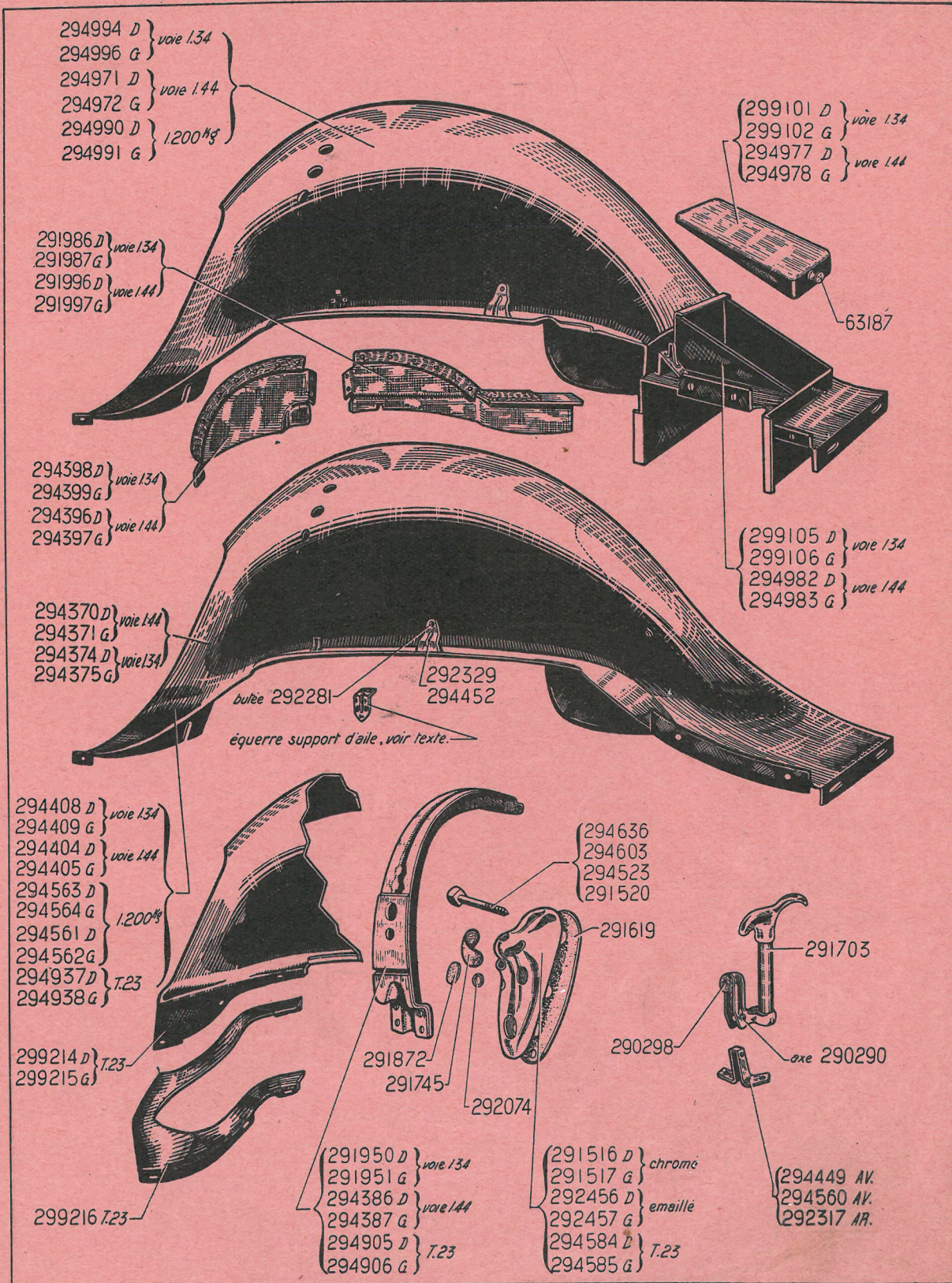

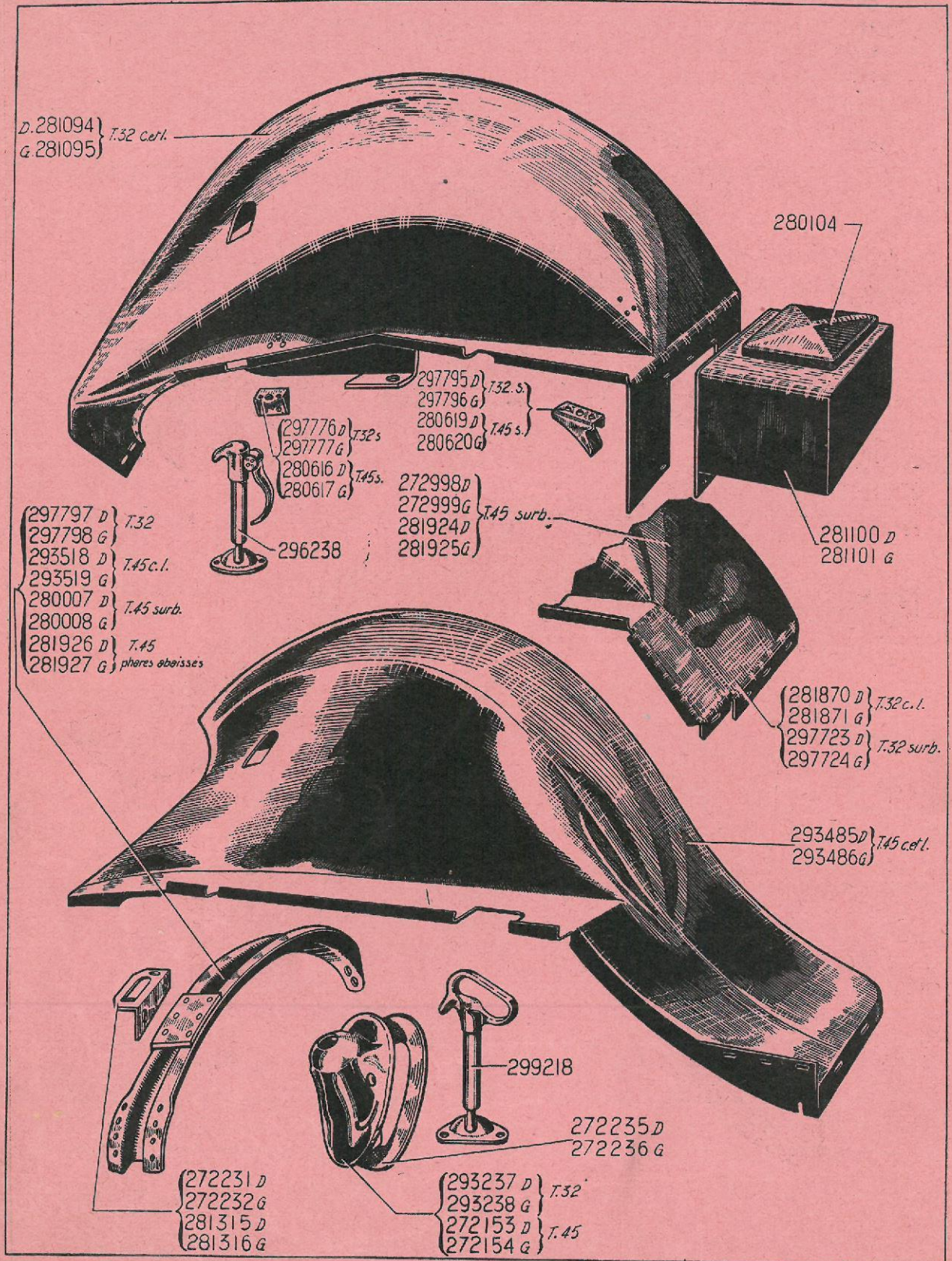

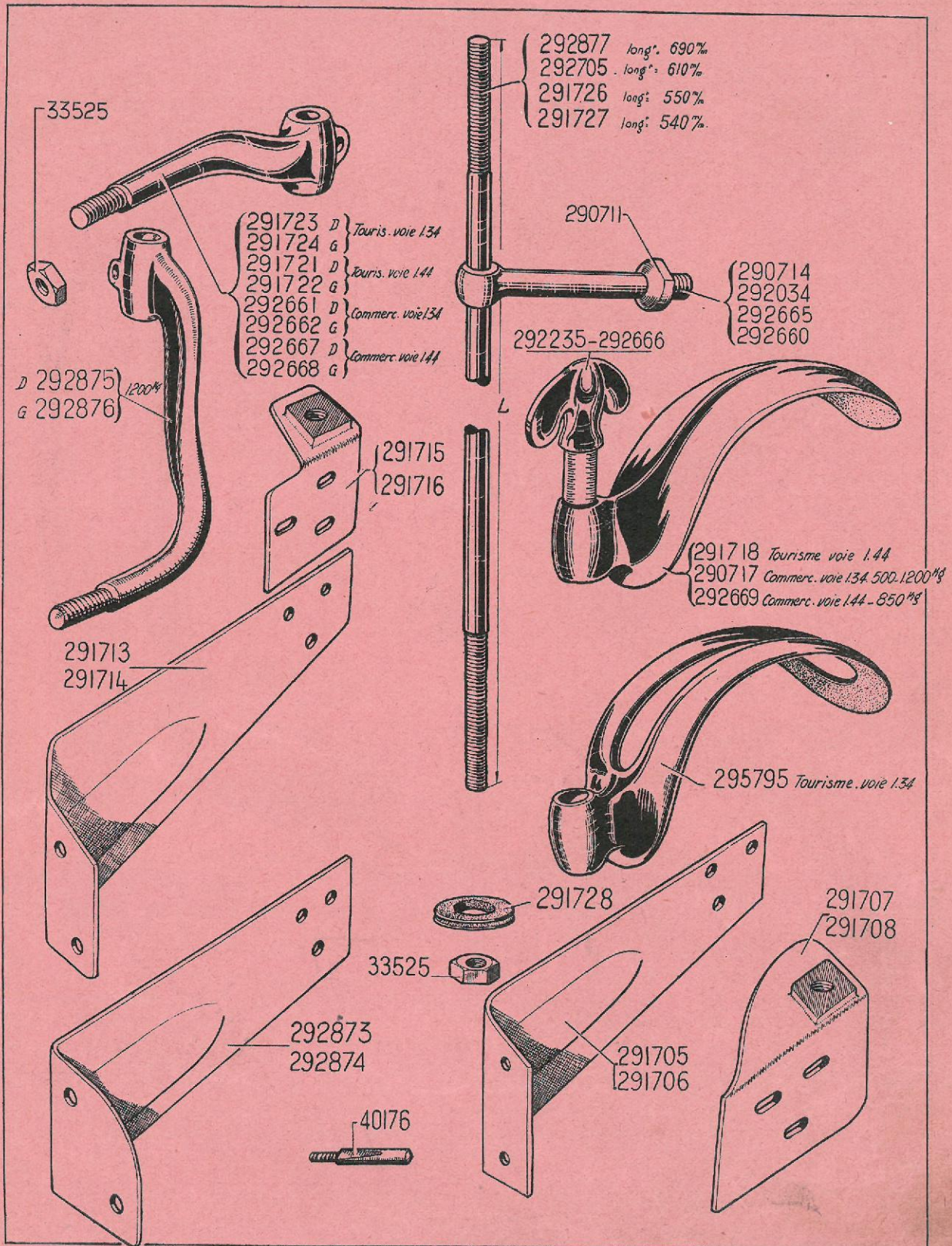

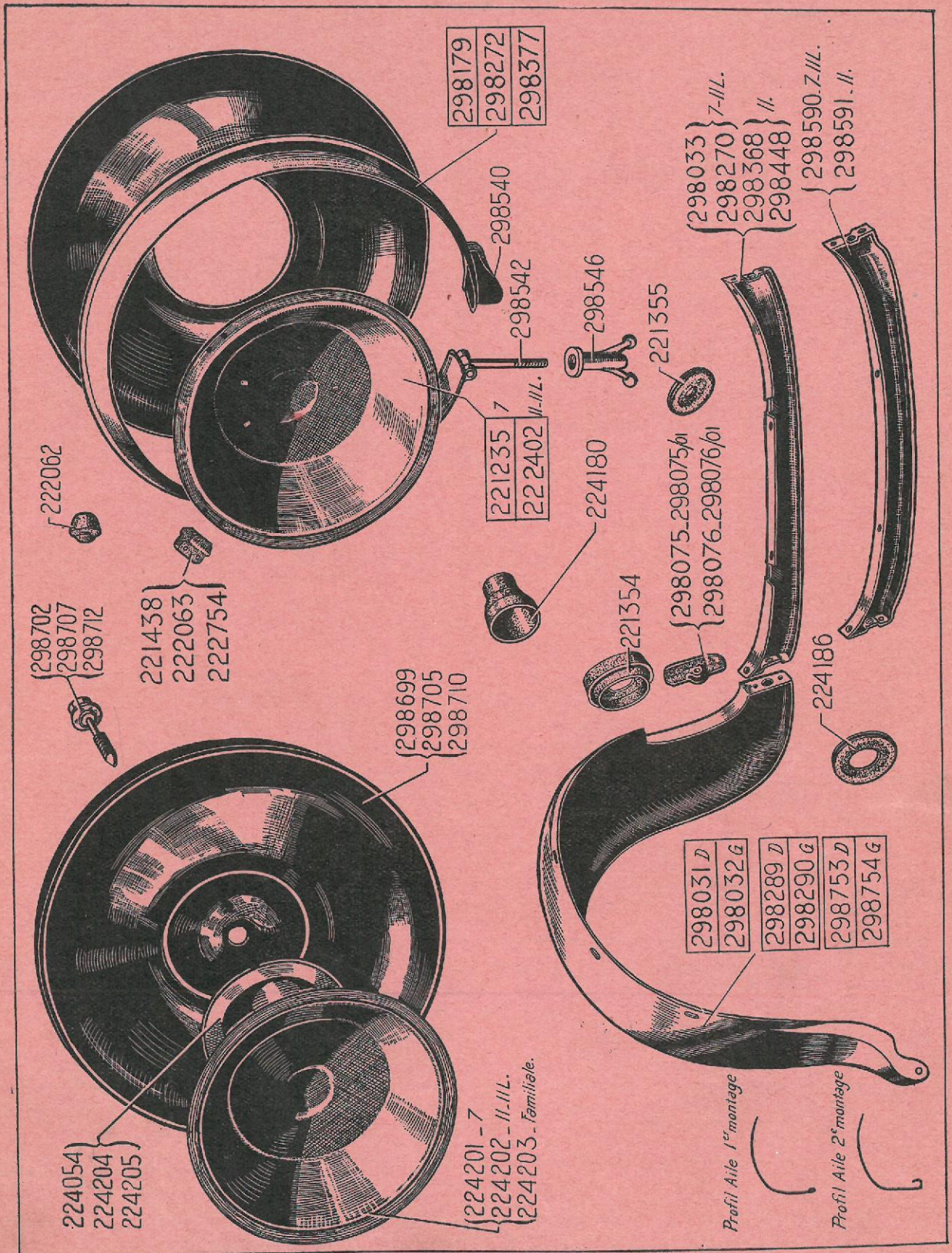

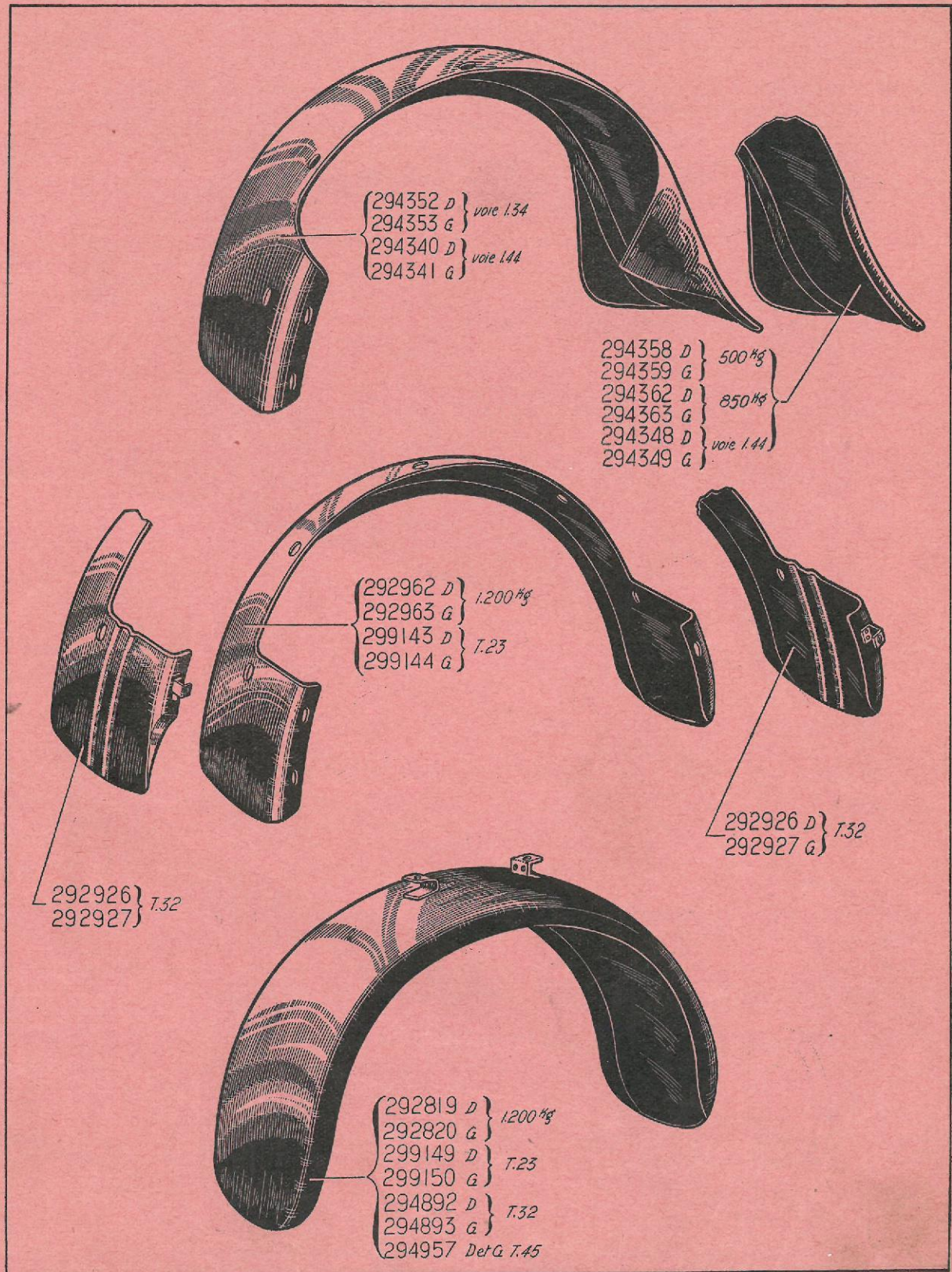

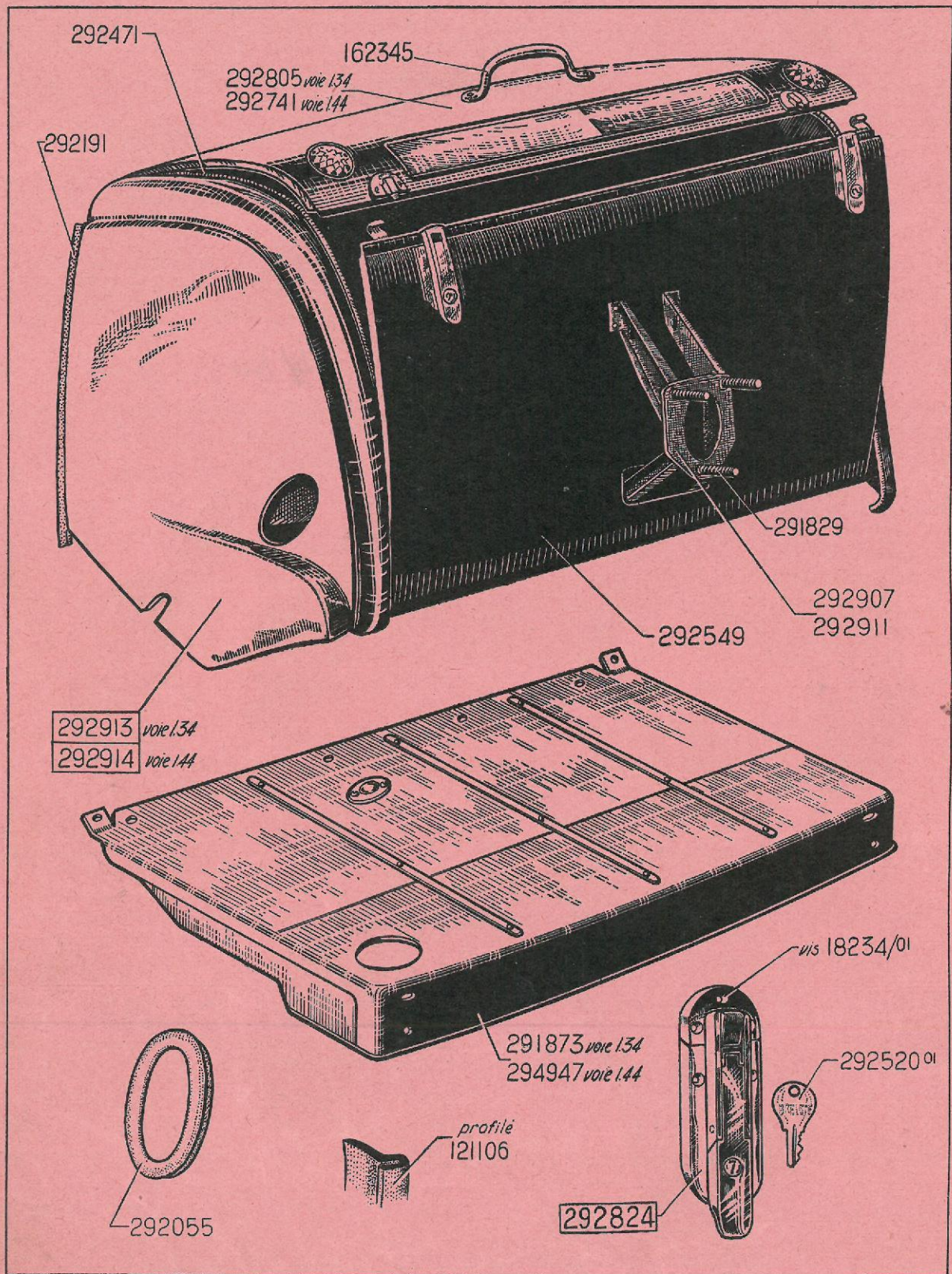

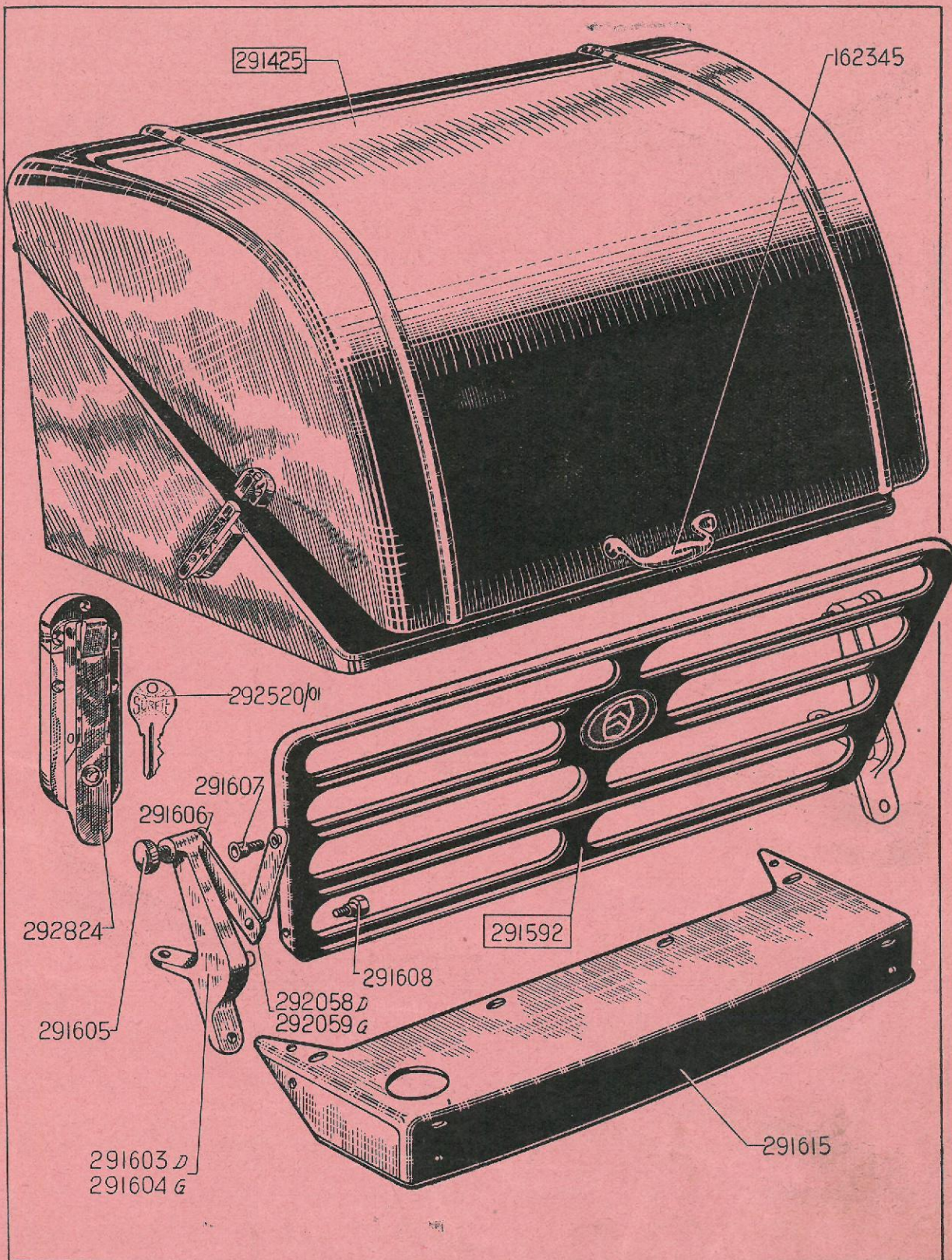

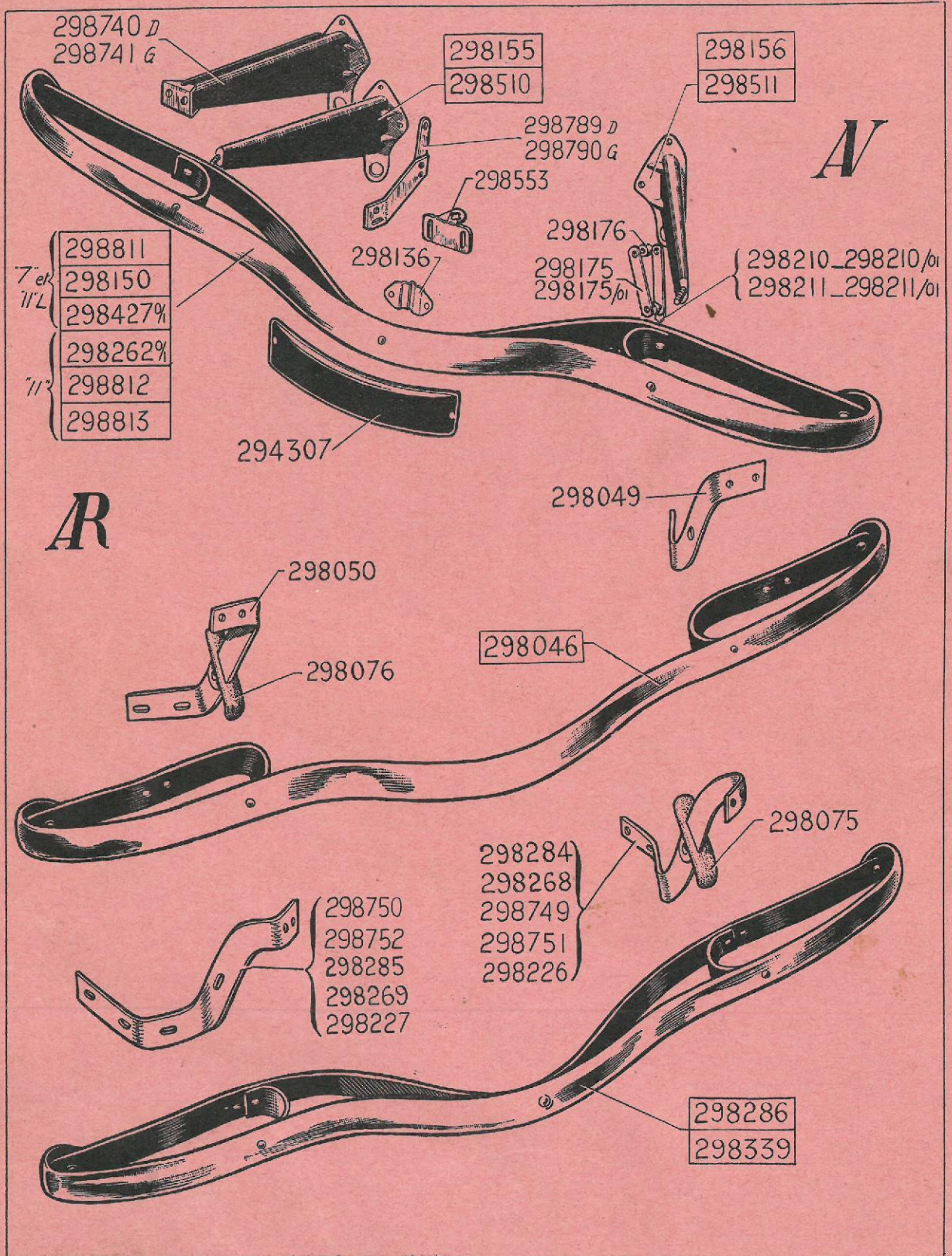



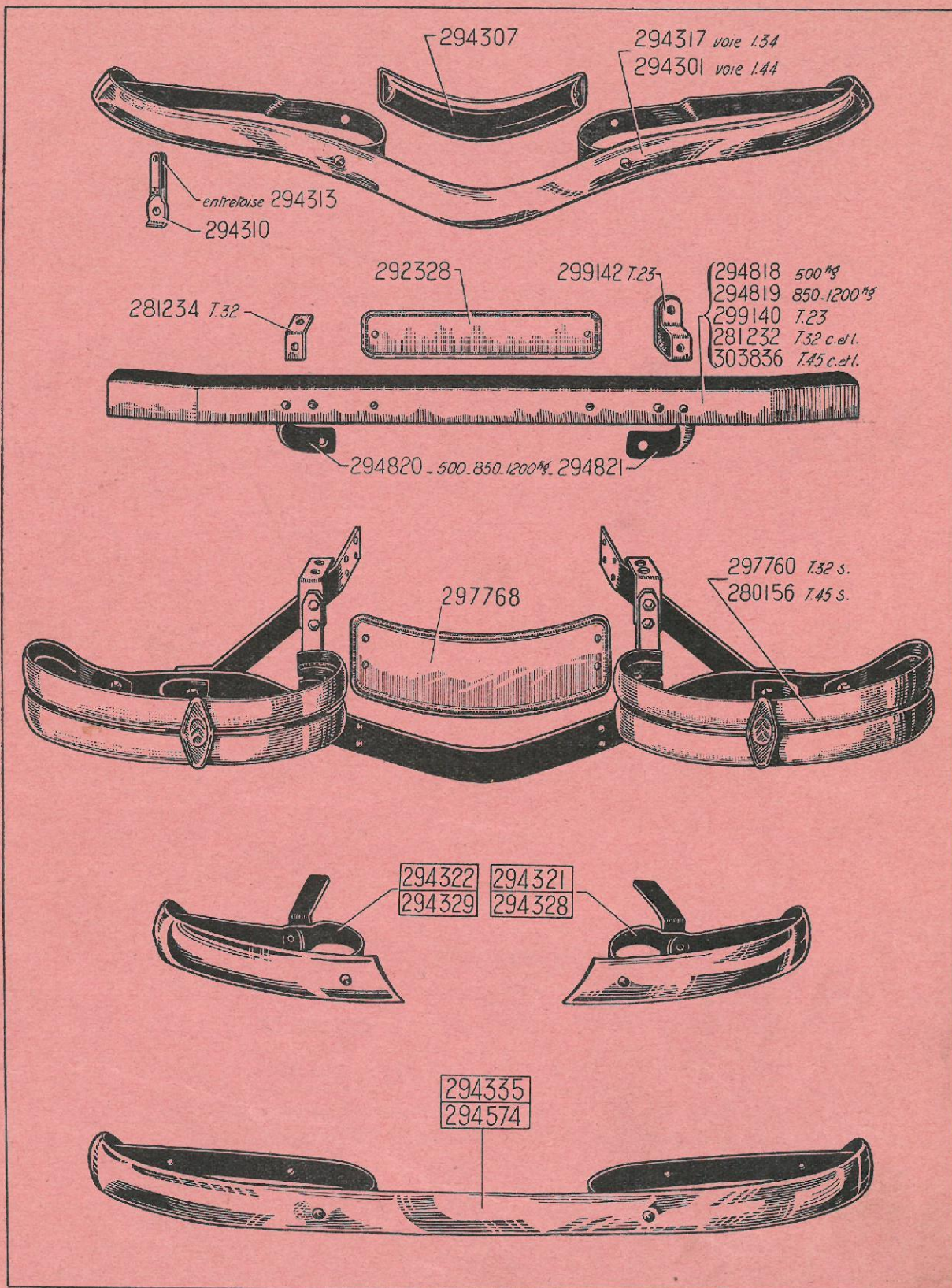



{ 291558 D } voie 1.34  
{ 291559 G }  
{ 291564 D } voie 1.44  
{ 291565 G }

{ 294435 D } voie 1.34  
{ 294436 G }  
{ 294431 D } voie 1.44  
{ 294432 G }

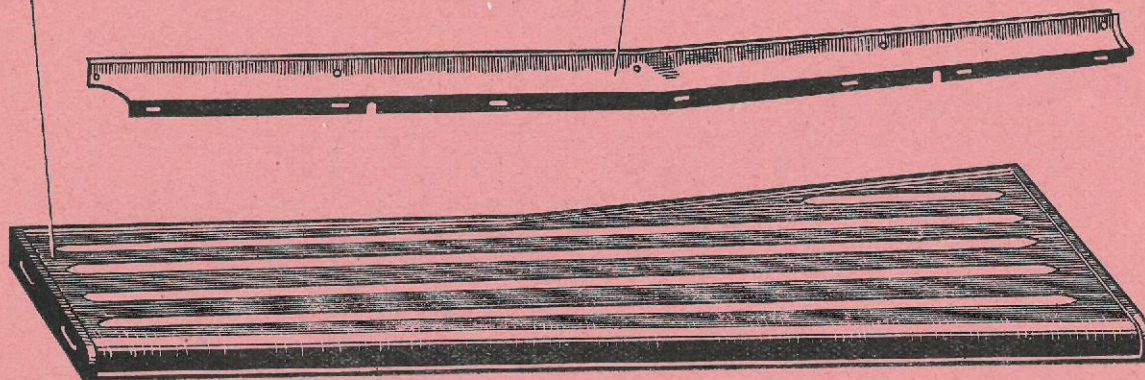

{ 294550 D } 1.200 kg  
{ 294551 G }  
{ 294894 D } 1.25  
{ 294895 G }  
{ 281135 D } 1.32  
{ 281136 G }  
{ 281892 D } 1.32  
{ 281893 G }  
{ 293559 D } 1.45  
{ 293560 G }

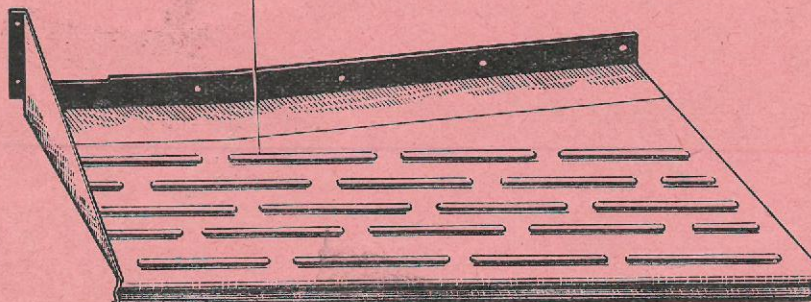

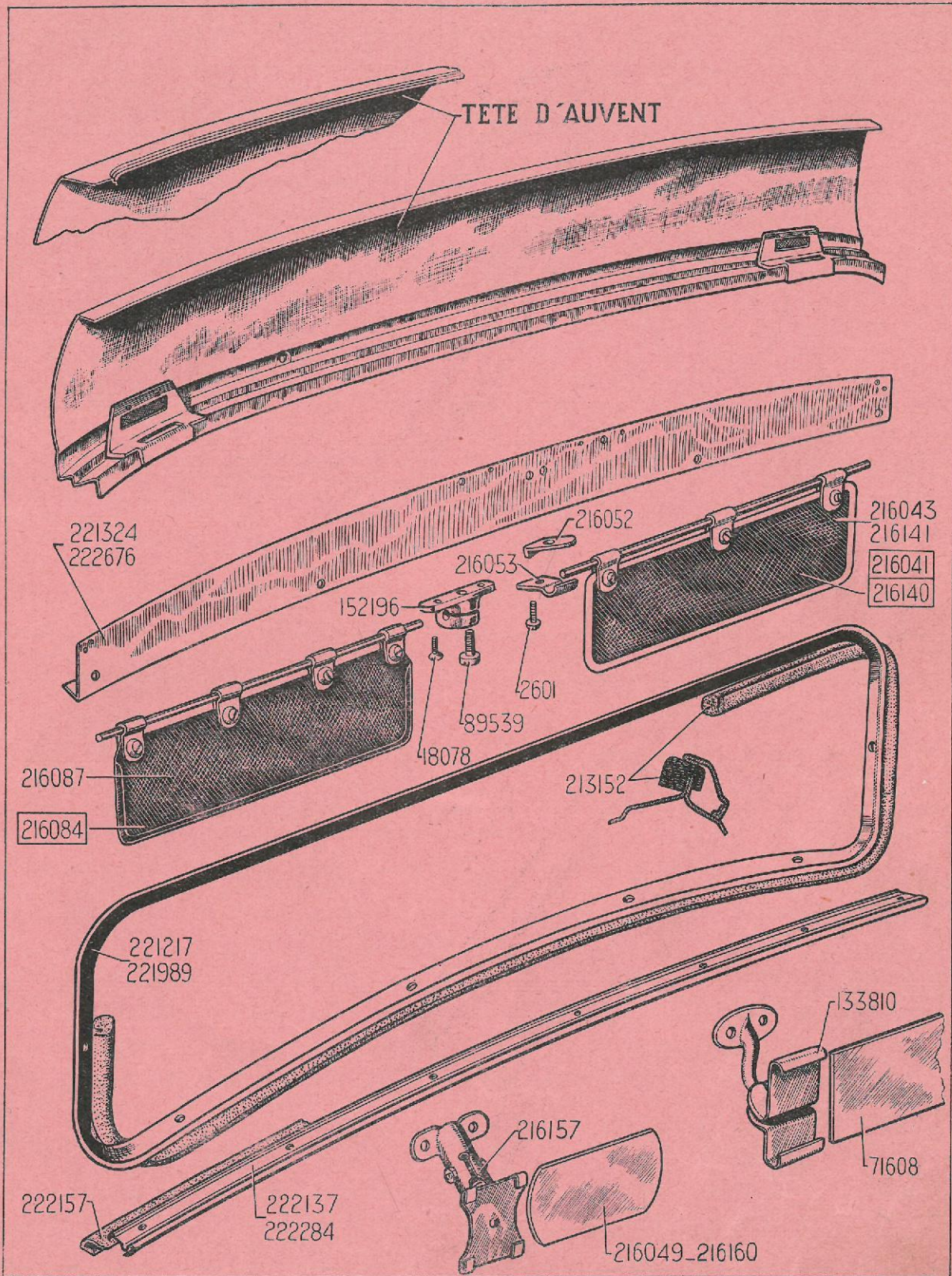

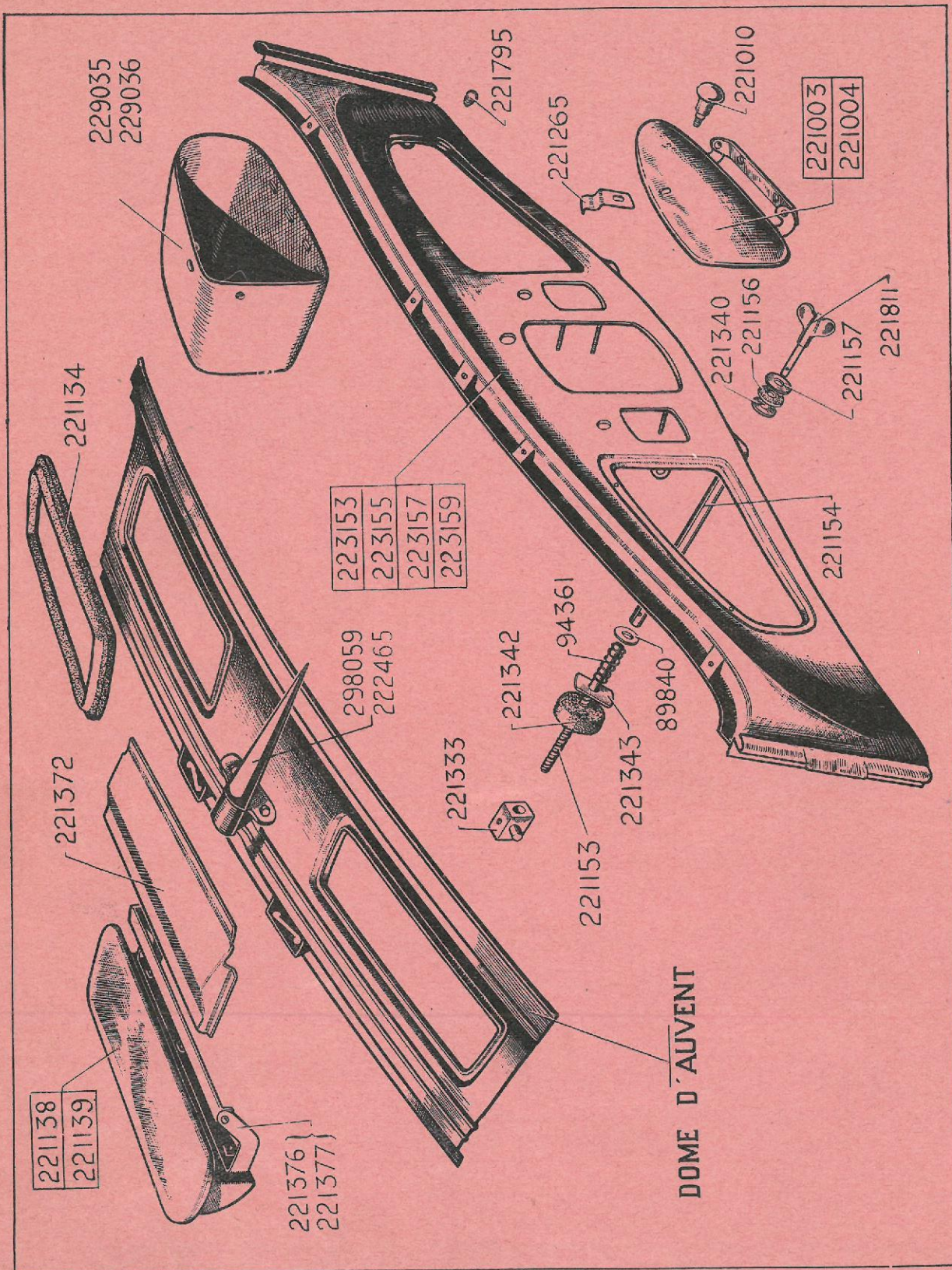

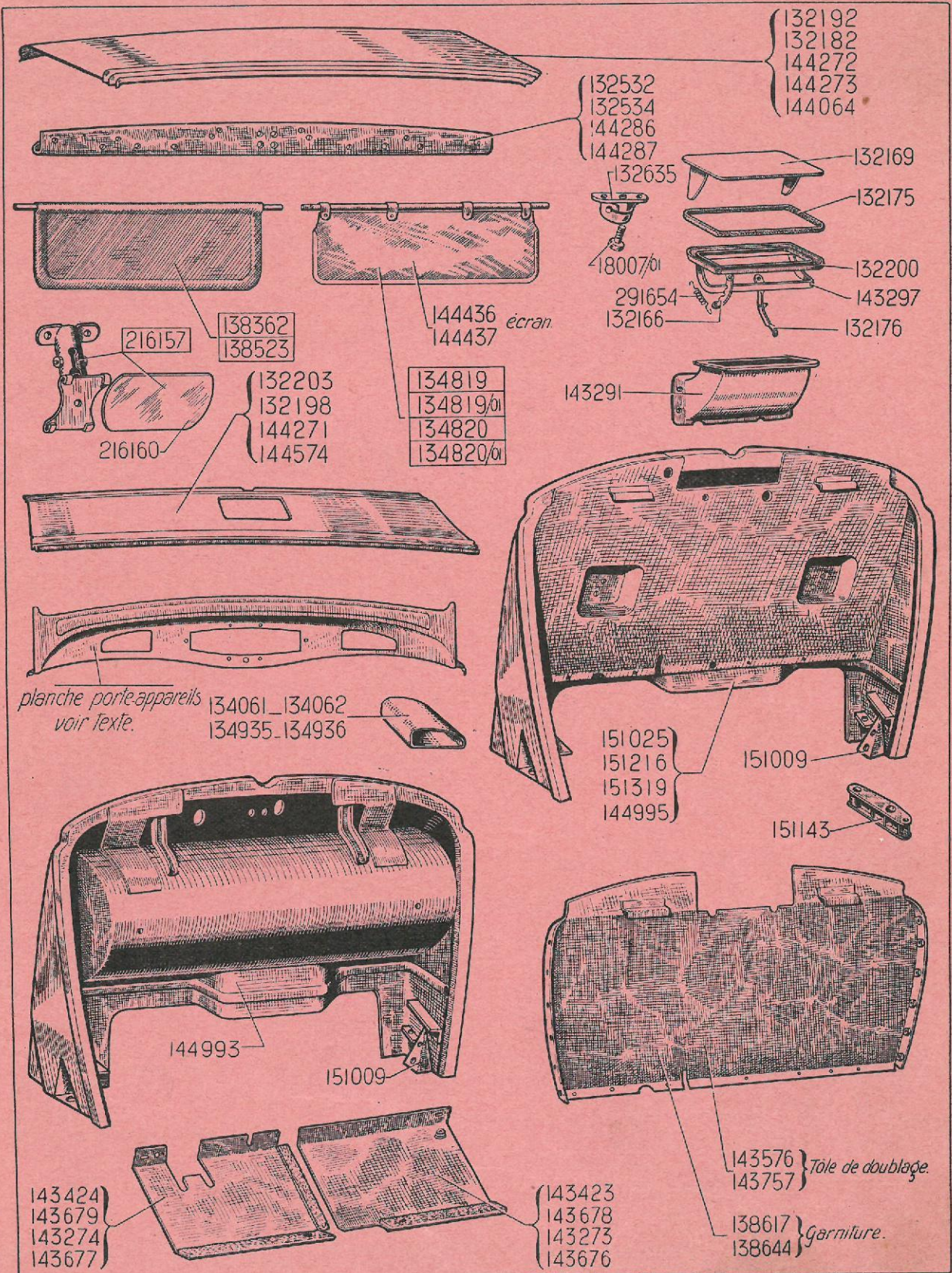

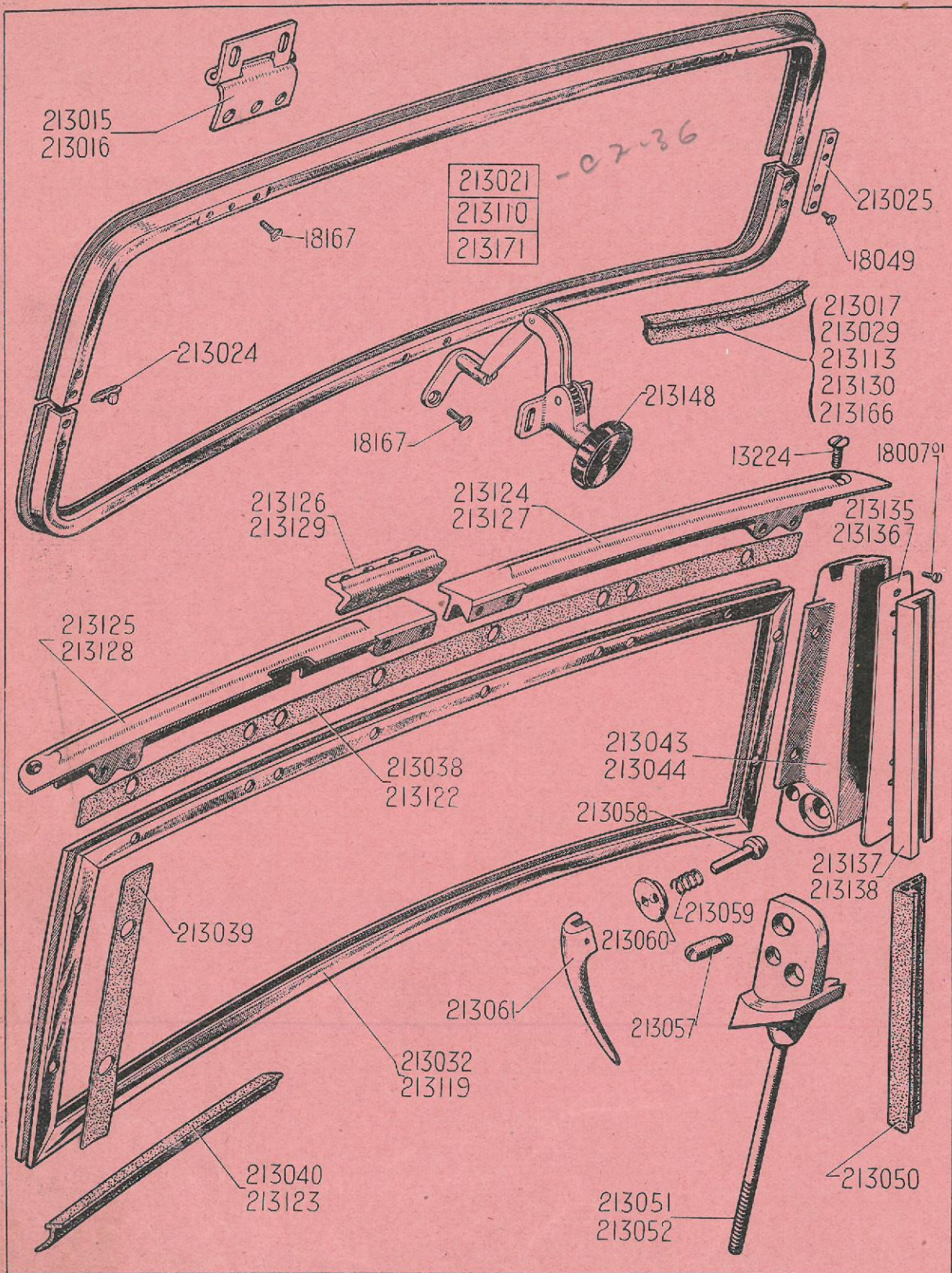

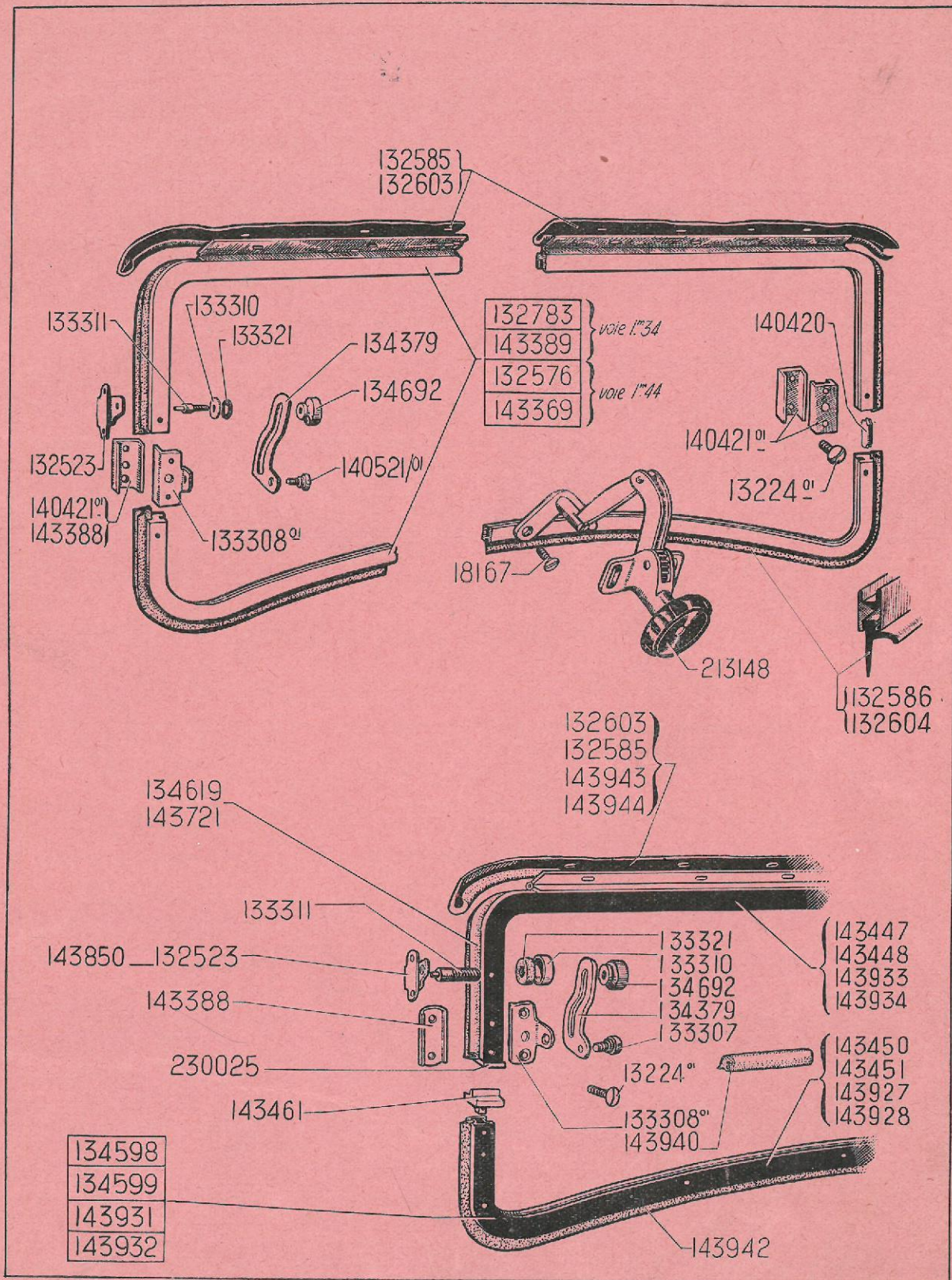



*Pare-Brises*

71591

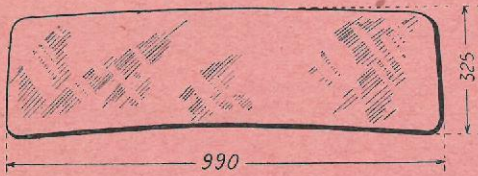

71603

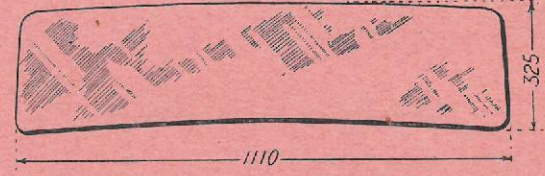

71599

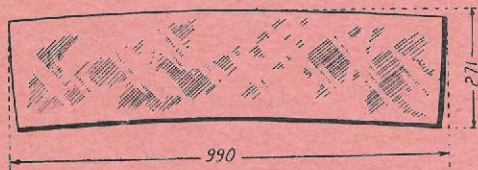

71604

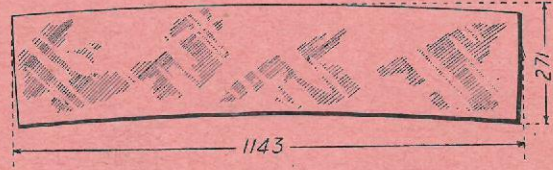

*Portes AV et AR*

71593



71594

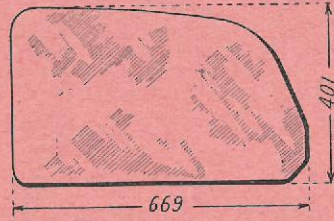

*Custode*

71606

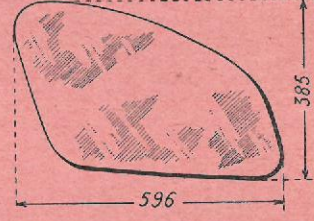

71597

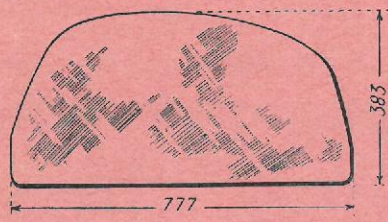

71601

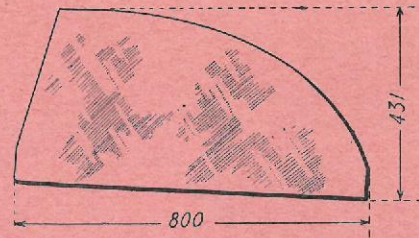

*Lunettes AR*

71592



71600



71605







*Pare - brise*

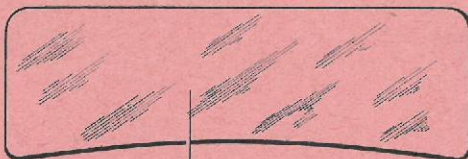

71700  
71699



{ 71640  
71638  
71645  
71646

{ 71639  
71637  
71643  
71644

*Portes AV.*

*Tourisme.*



71694

*Utilitaire.*



71636

*Portes AR.*

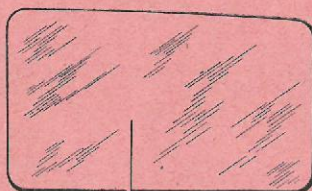

71695

*Custodes.*

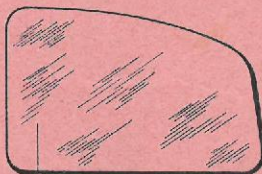

{ 71696  
71697  
71623

*Lunettes.*



71698

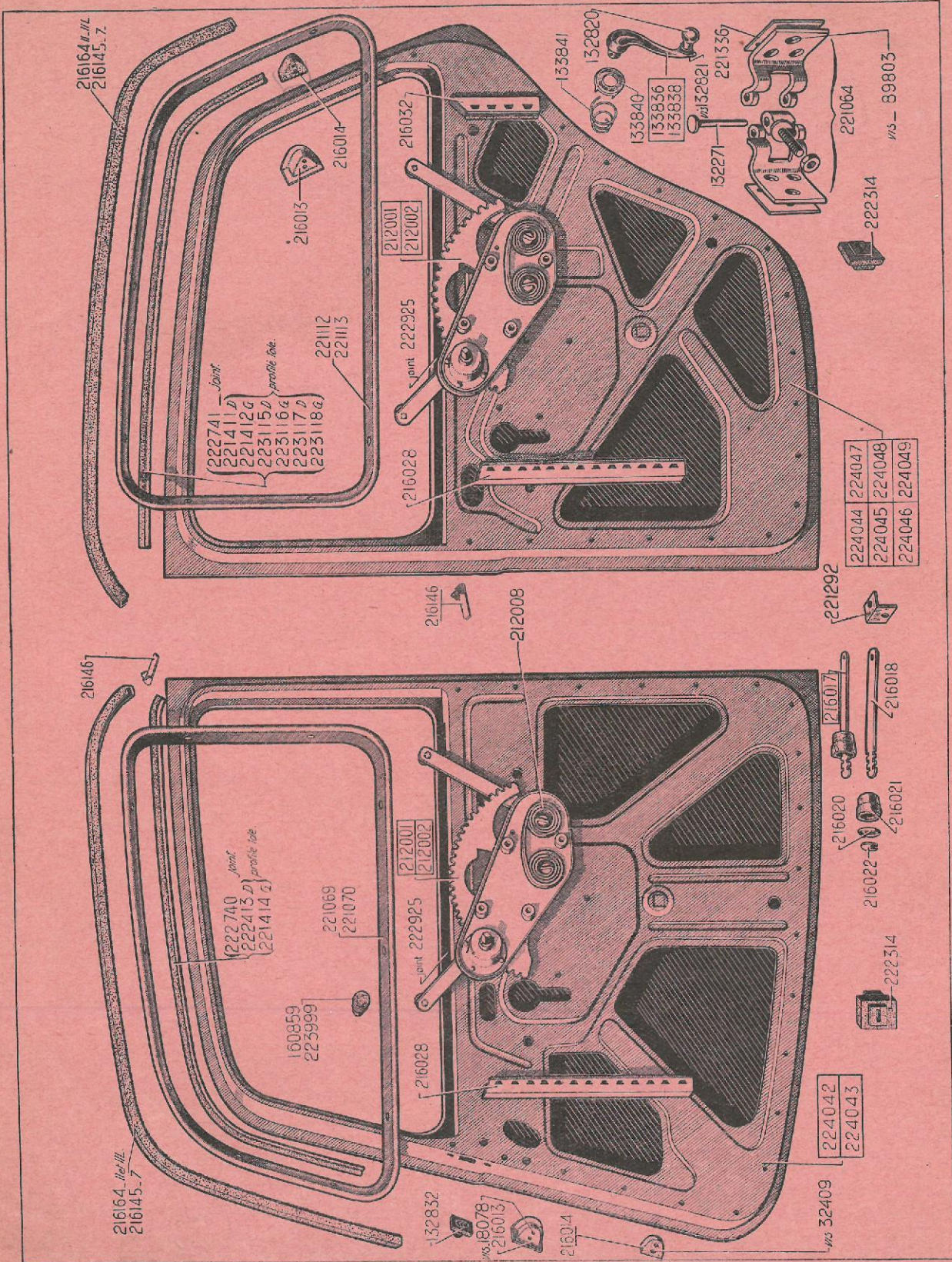



**PORTIÈRES CABRIOLET  
ET ROADSTER 7 ET 11**

**PORTES COMPLÈTES  
ÉLÉMENTS**

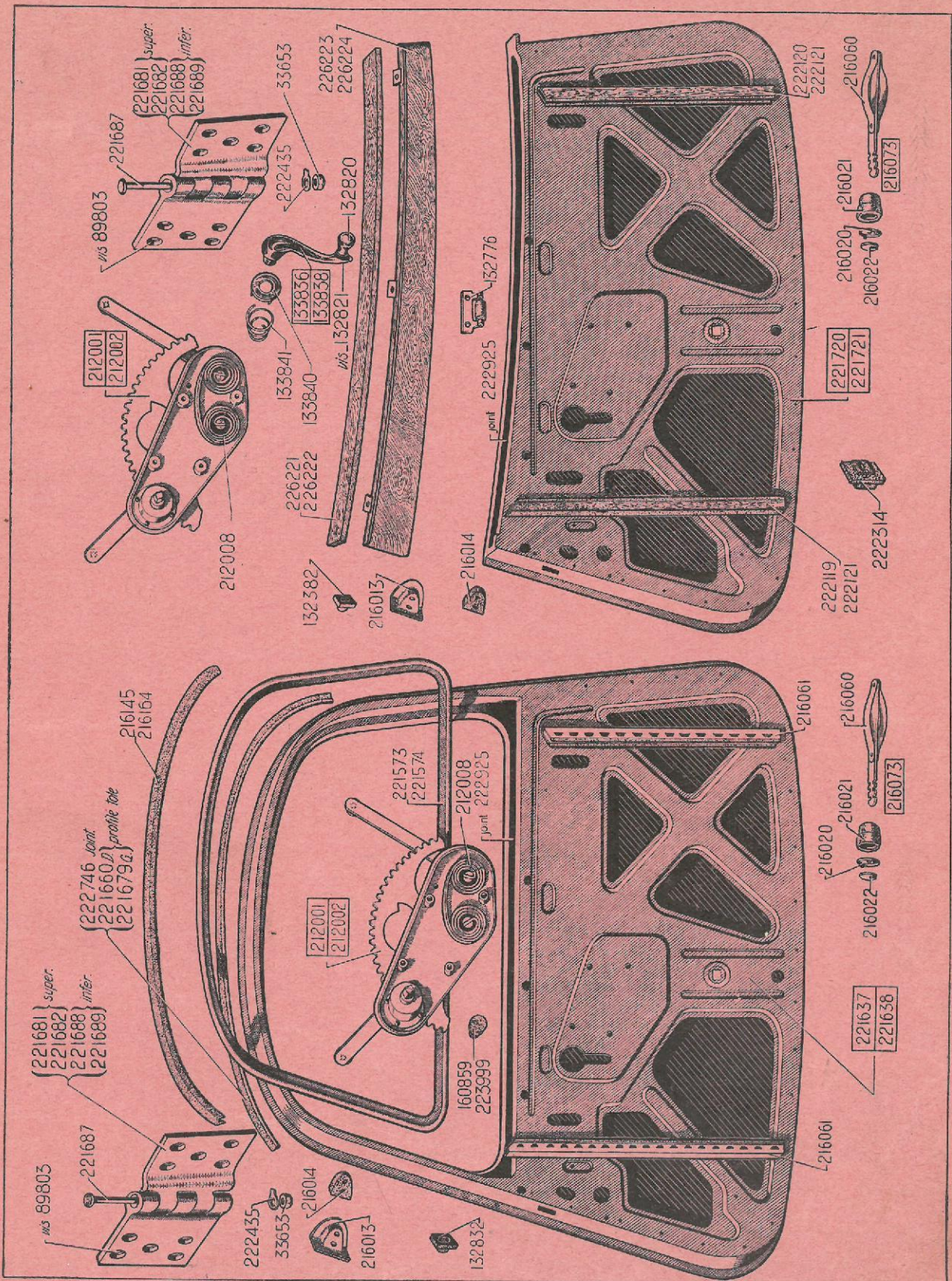



**PORTIÈRES**  
TT sauf 7 et 11

**PORTES COMPLÈTES**  
**ÉLÉMENTS**

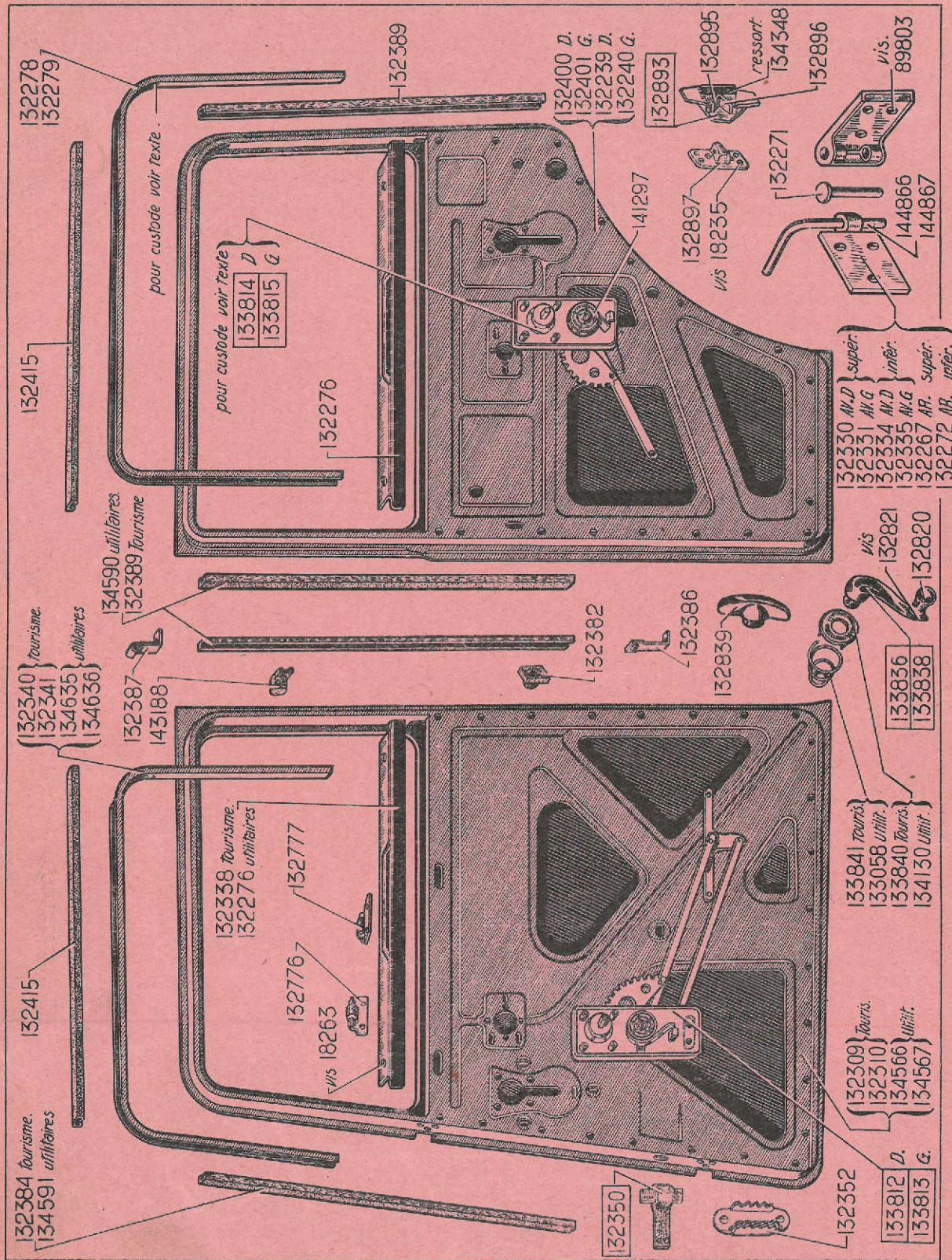

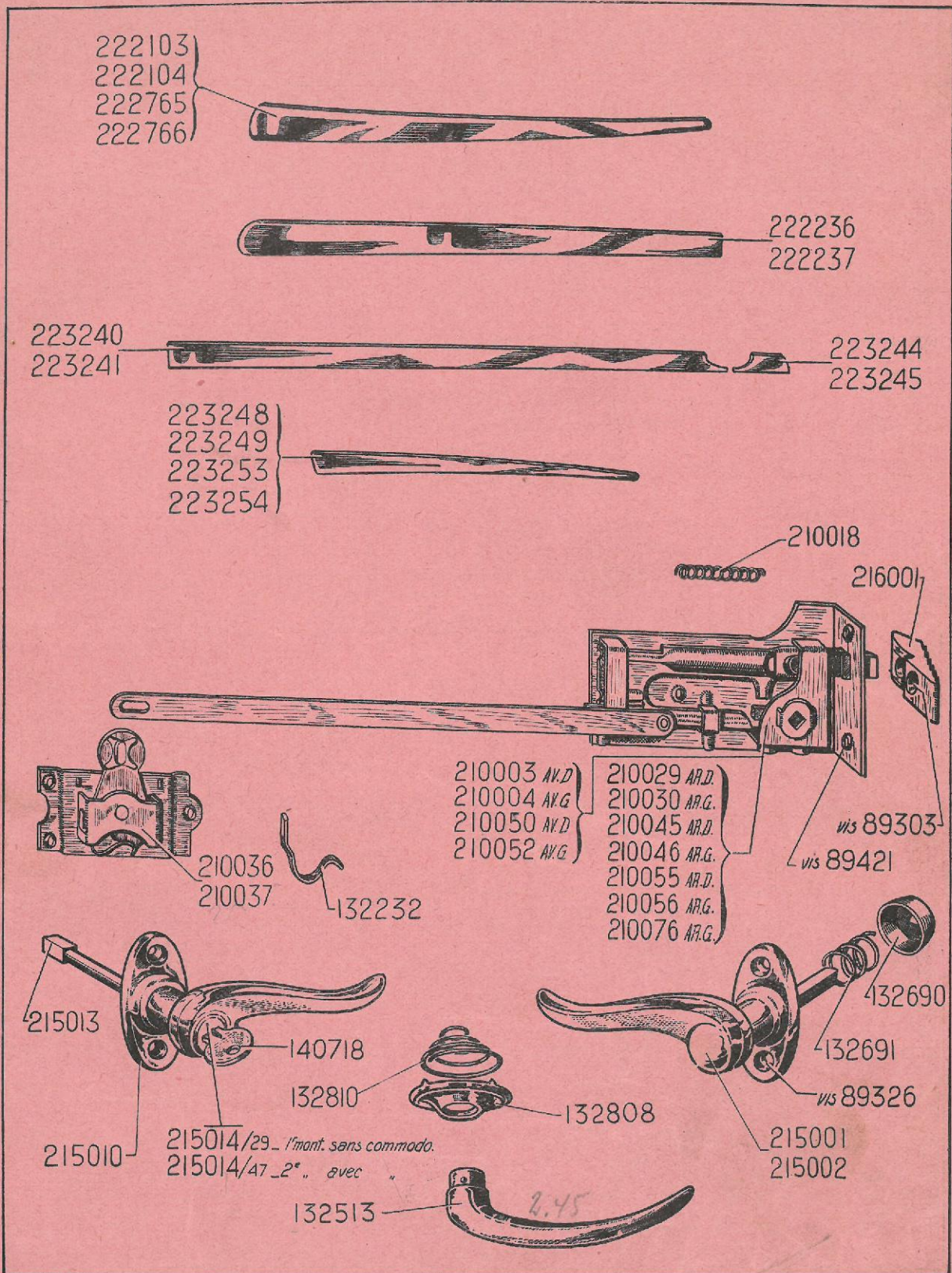

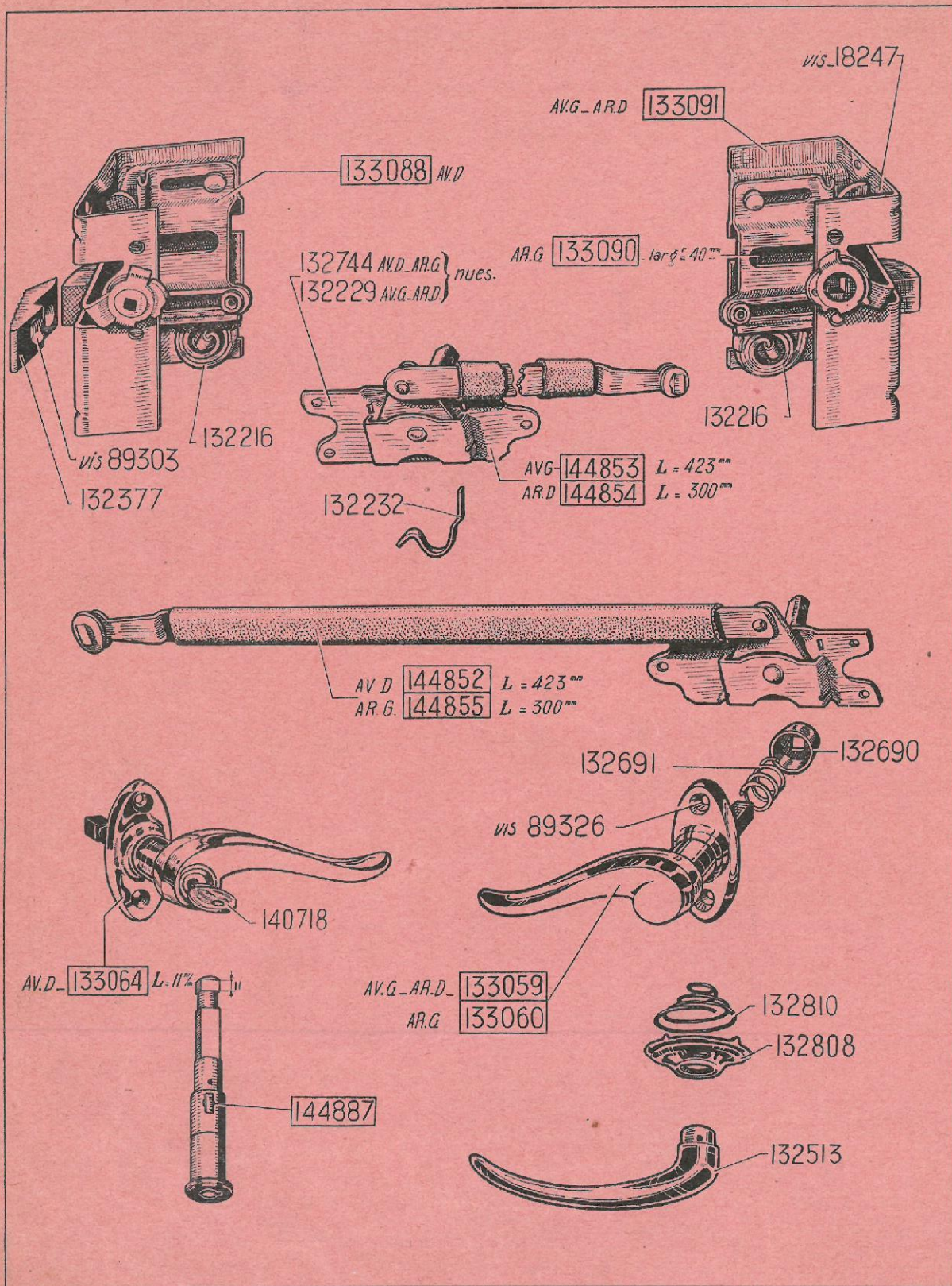

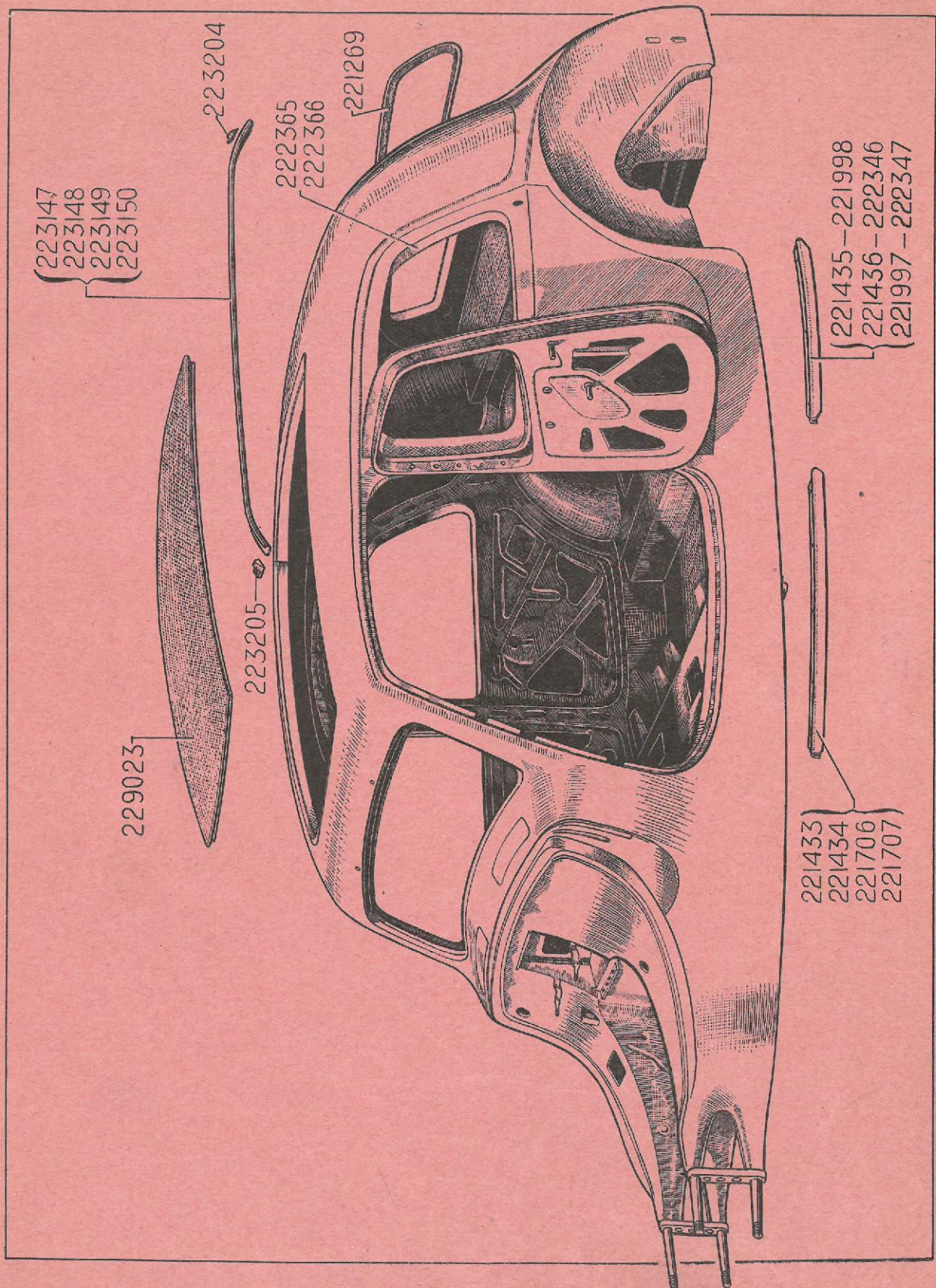



# ÉLÉMENTS DE CARROSSERIE 7 et 11

# COFFRE DE SPIDER ET COFFRE A BAGAGES

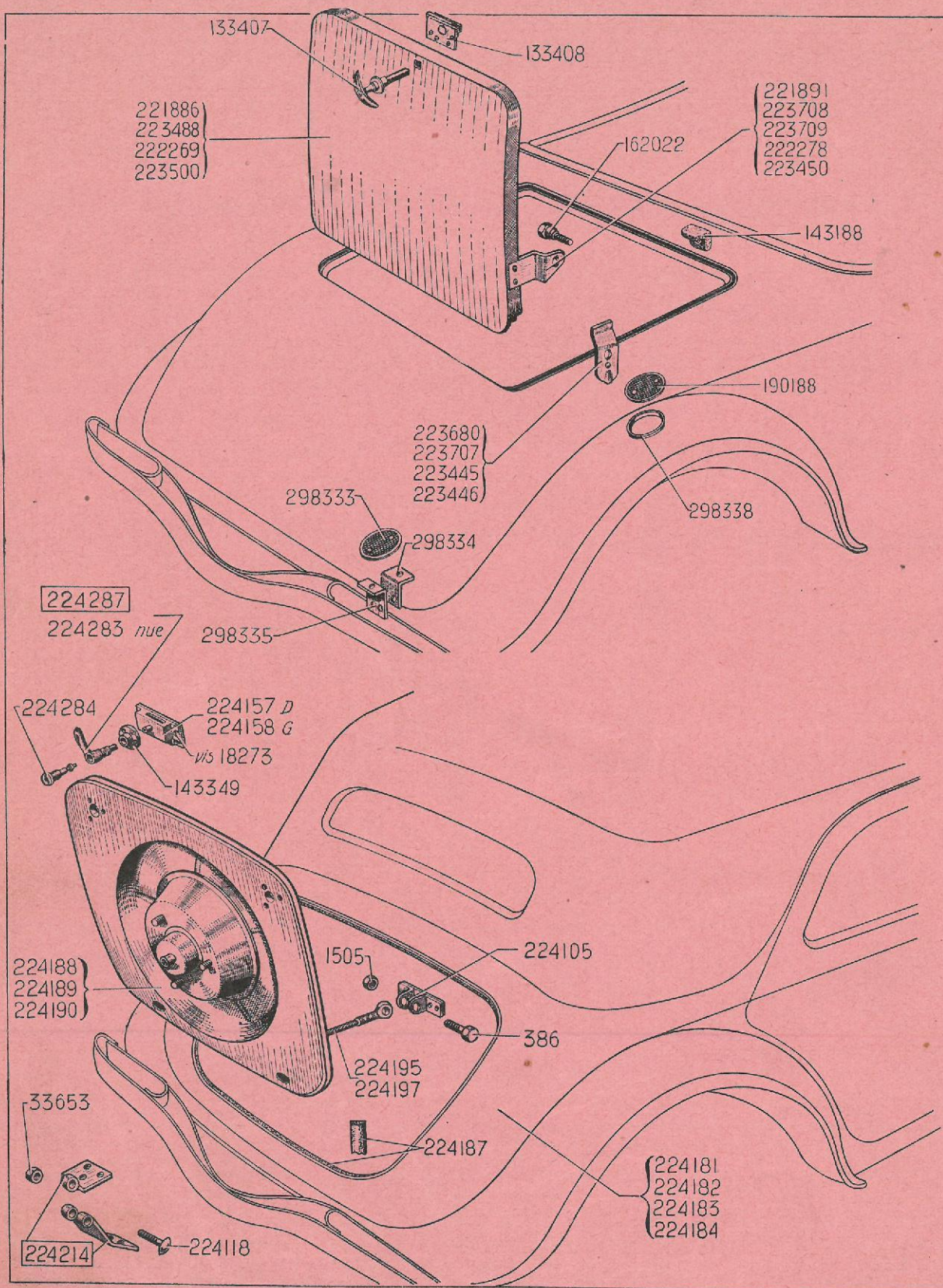



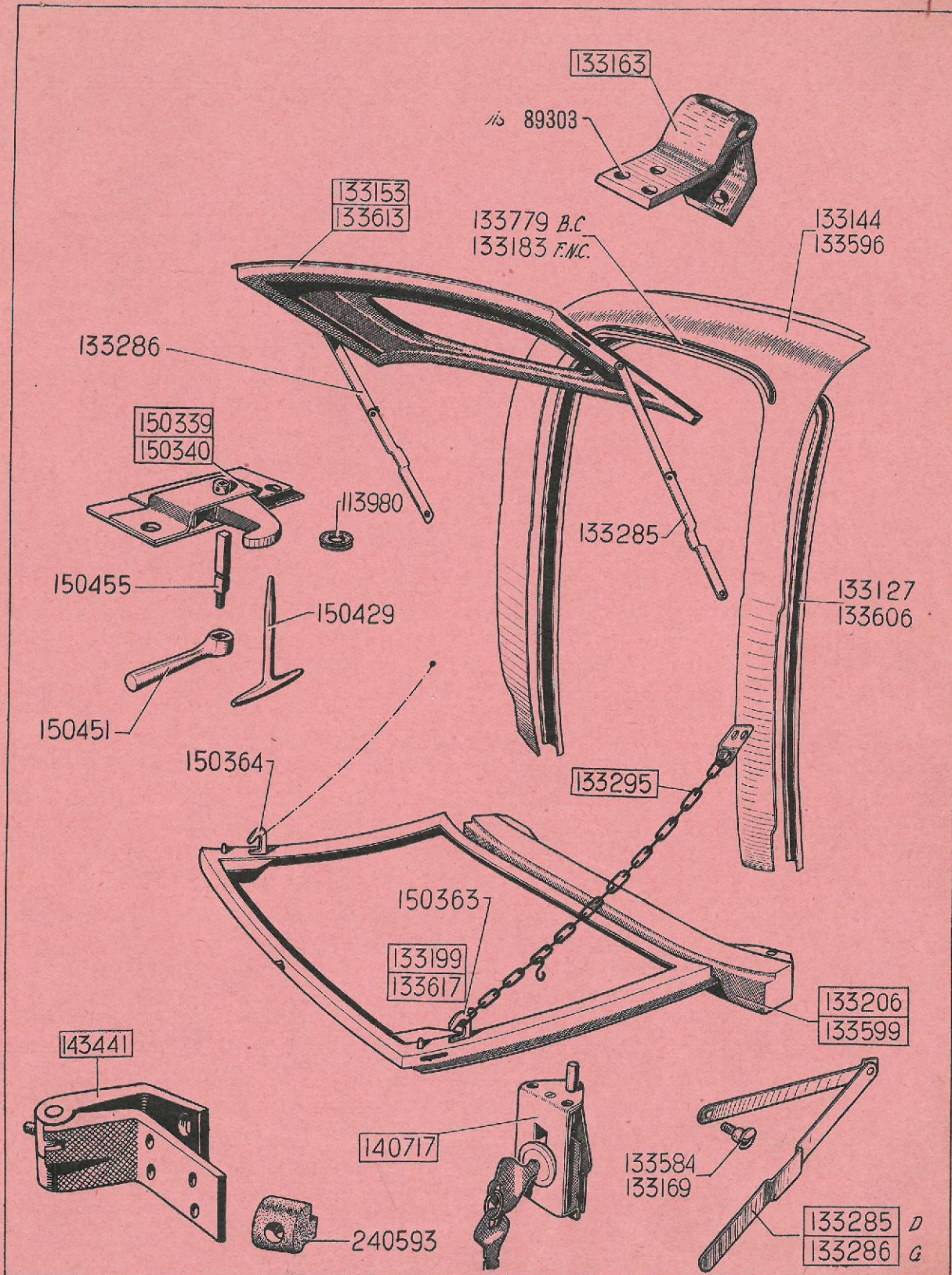



# ÉLÉMENTS DE CARROSSERIE

## TT sauf 7 et 11

### PLANCHERS

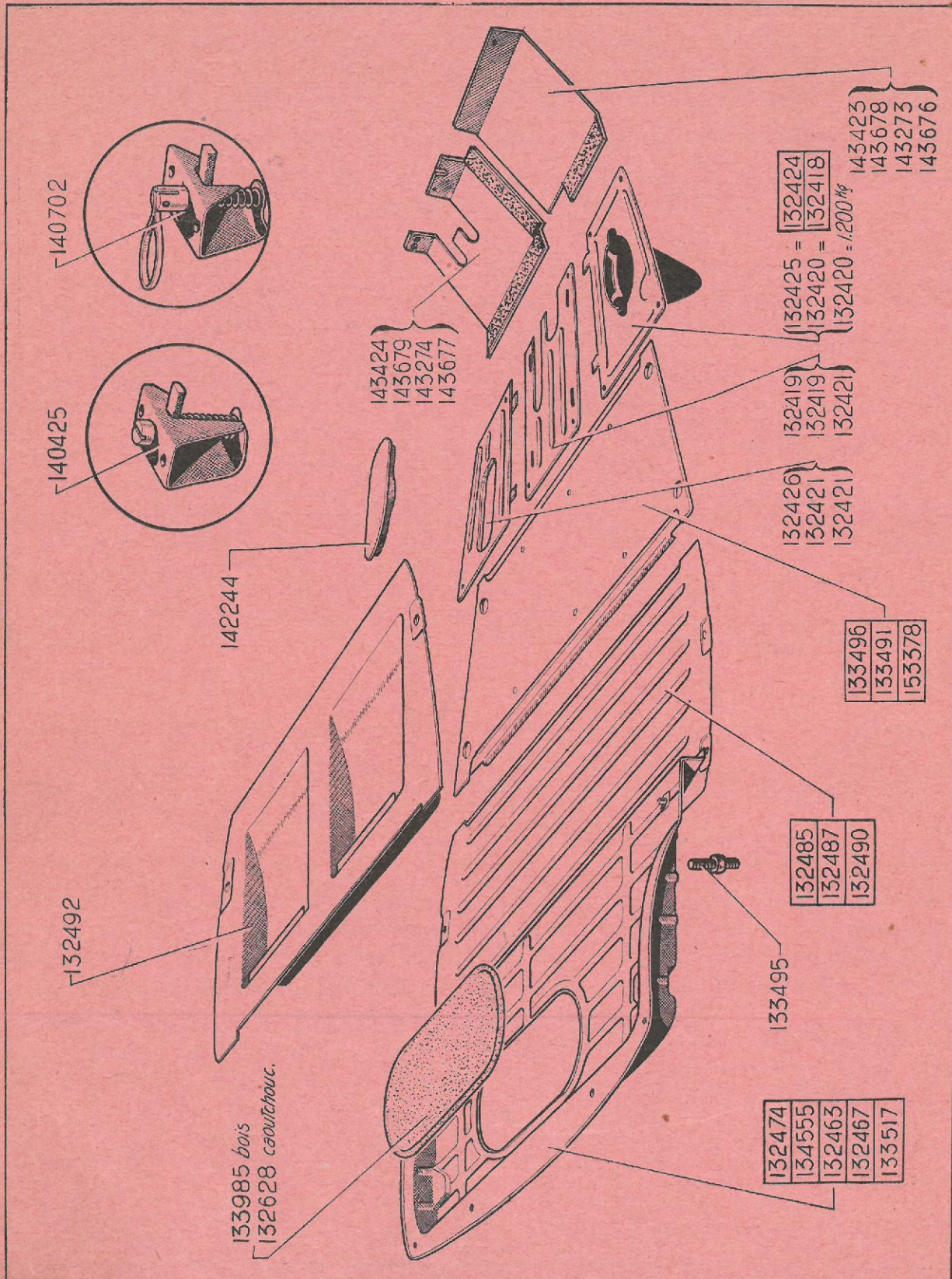

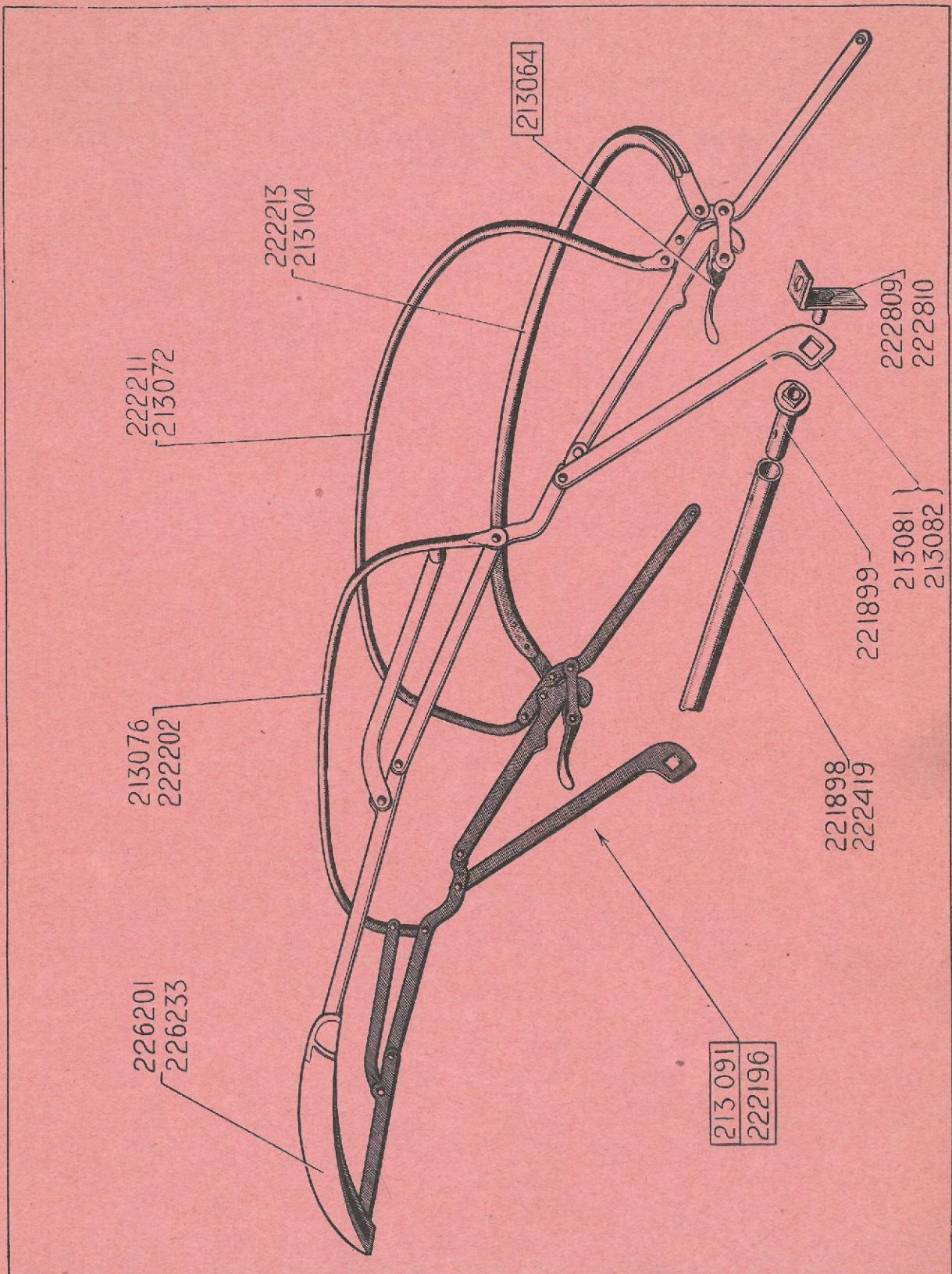



**B.P.V.L.**

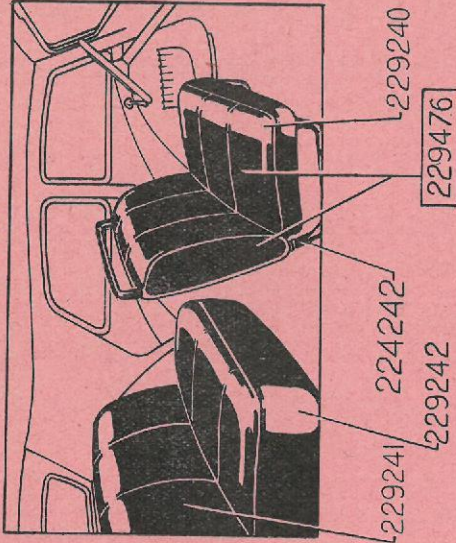

**R.P.V. — R.P.V.S. — R.P.V.L.**

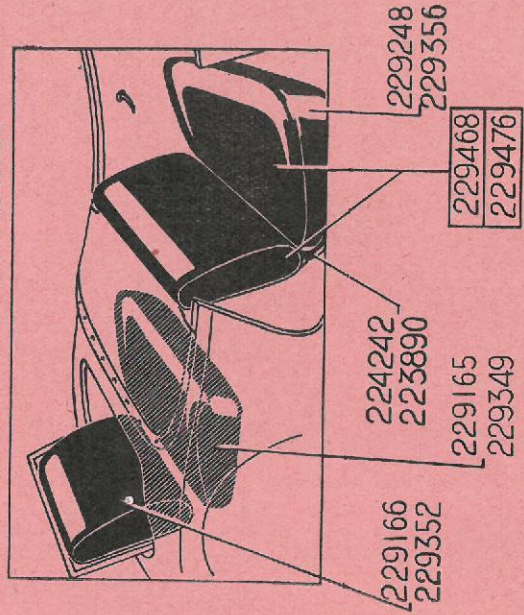

**B.P.V. — B.P.V.S.**

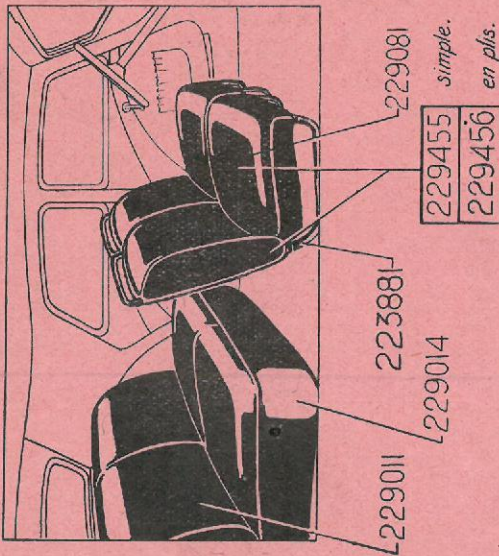

**C.P.V. — C.P.V.S.**

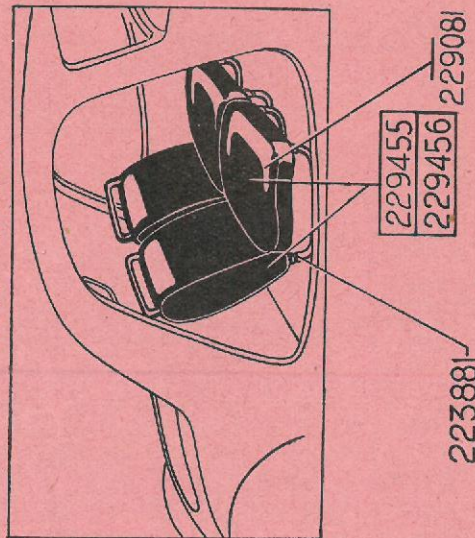



F.P.V.F — 9

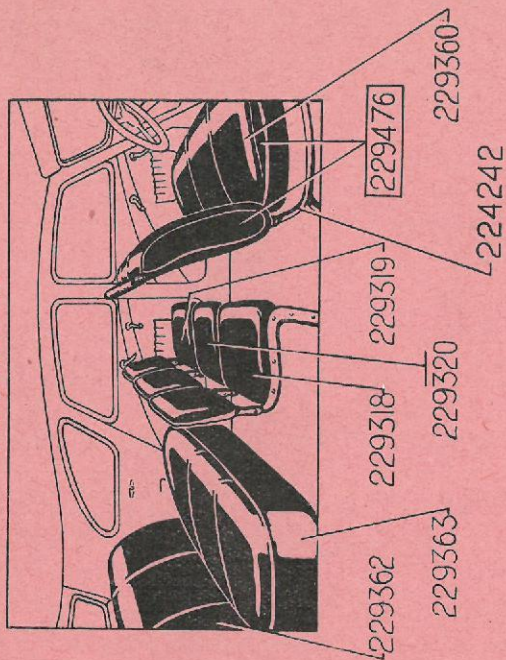

S.P.V.F — 6

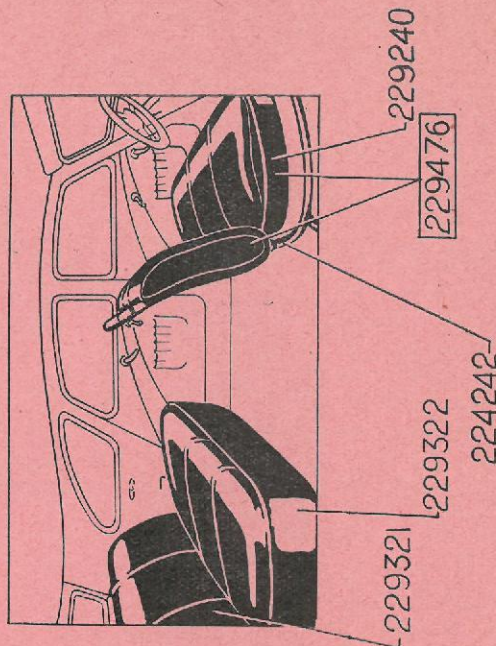

F.P.V.F — 7

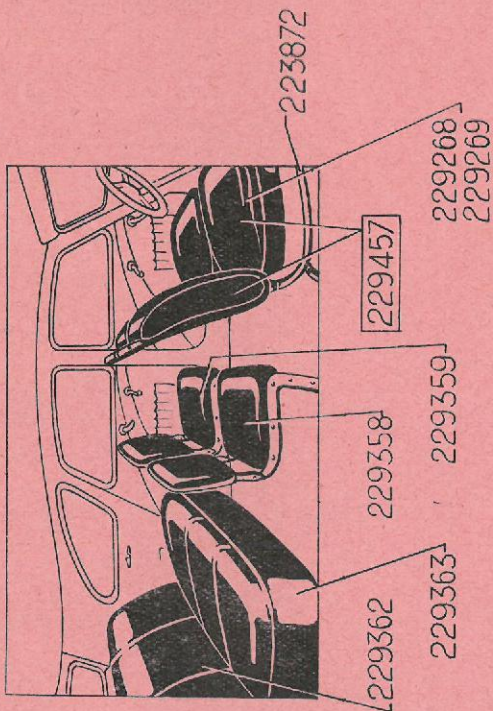

S.P.V.F — 5

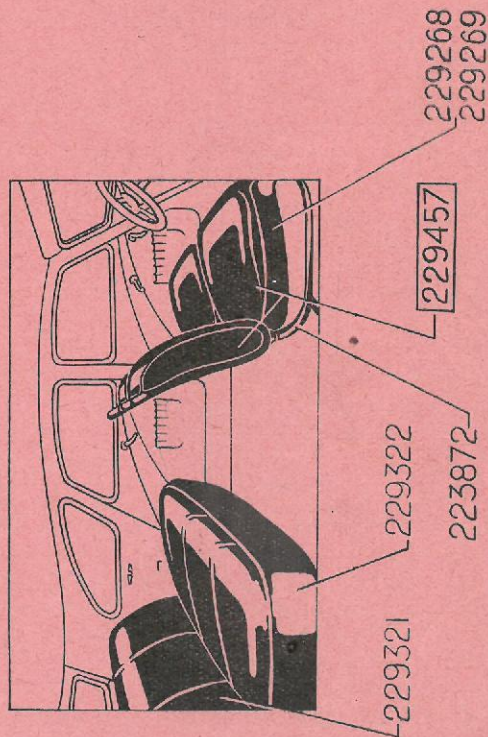



**C.N.\_F.N.\_F.N.C.\_**

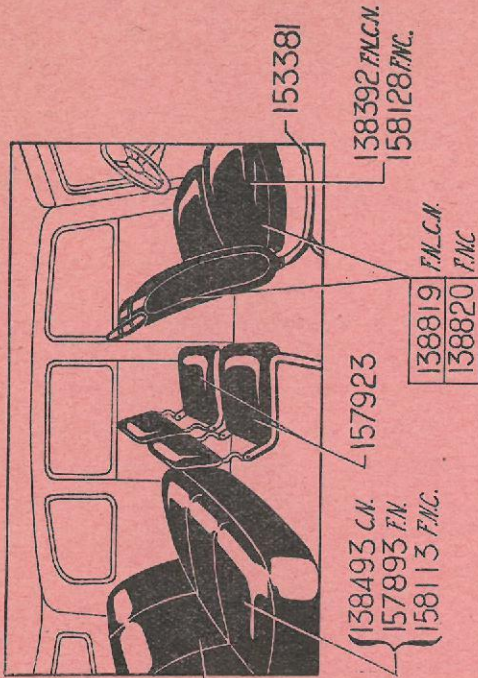

**B.L.\_B.C.\_B.N.\_B.N.C.\_**

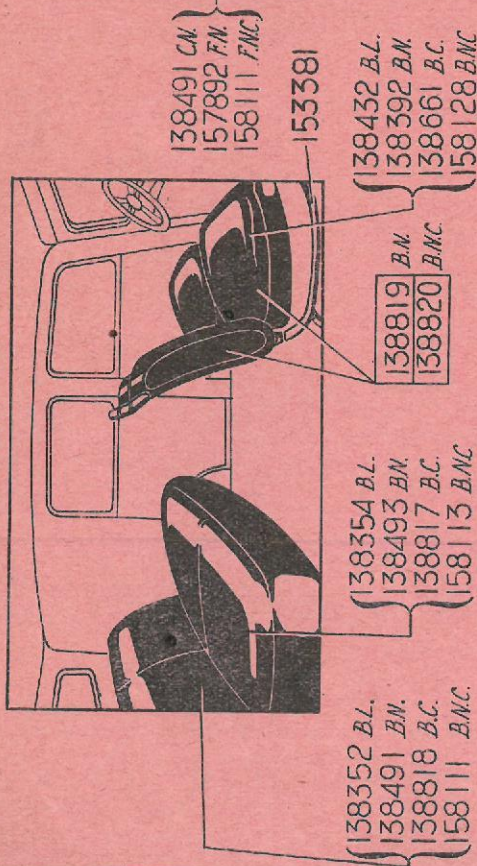

**UTILITAIRES\_**

